



## Multi-Fire XD™

33" Plug-in Electric Firebox

PF3033HL



The best of combustion and electric  
- in one remarkable firebox.

The sleek full view design allows an unencumbered view of the stunning Realogs™, the second generation of our patented inner glow technology. The dazzling Multi-Fire XD™ can accurately reproduce a natural wood-burning fire, gas fireplace or a range of ambient light themes that range from moody and hypnotic, to pulsing and vibrant.











MultiFire XD™

## Multi-Fire XD™ 33" Plug-in Electric Firebox

## PF3033HL



### Features

-  **Multi-Fire XD™ Flame Effect**  
Vivid flames that are brighter and more lifelike day or night.
-  **Realogs™**  
Molded from meticulously selected and charred hardwood and positioned to maximize the illusion of depth and the appearance of burning firewood.
-  **ComfortSaver™ Heating System**  
The patented ComfortSaver™ ceramic heating system uses 11% less energy than the leading quartz infrared heater by automatically adjusting fan speed and heater wattage to safely and precisely match the requirements of the room.
-  **Media Accent Colors**  
Choose from a variety of brilliant color themes or cycle through a range of colors using the custom mode, freezing on the hue of your choice.
-  **Flame Accent Colors**  
Accent the flames with custom base colors from warm red to gas blue.
-  **Precision Thermostat**  
Electronic thermostat maintains room temperature within 1/2°C (1°F) for perfect comfort and increased energy efficiency.
-  **Economical**  
Economical to operate costing only pennies per hour.\*
-  **Low Carbon Footprint**  
The most sustainable fireplace option; no emissions and 100% efficient.
-  **Mood-maker Remote**  
Customize the light color and intensity for a fireplace that reflects your personality.
-  **All-season Flames**  
Enjoy the unique charm of a fireplace 365 days a year using the flames without the heat.



Also available with Acrylic Ice: PF3033HG

### Color Themes

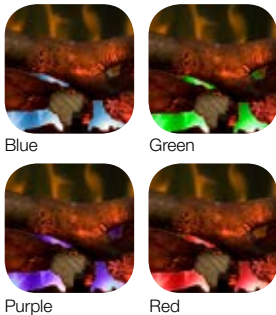

120 Volts | 1,500 Watts | 5,118 BTU

### Framing Dimensions

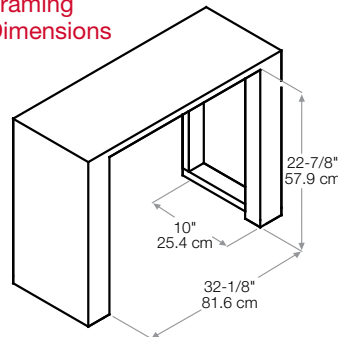

**Note:**  
The fireplace needs to be installed to ensure 35 in<sup>2</sup> (226 cm<sup>2</sup>) of intake air, into the back of the unit, on a continuous basis.

Model #	Description	Lbs / Kg	UPC	Wty. <sup>†</sup>	Carton Dimensions (WxHxD)		Cube	
					Inches	cm	ft <sup>3</sup>	m <sup>3</sup>
PF3033HG	33" Multi-Fire XD™ Electric Firebox - Acrylic Ice	60 / 27.2	781052 095038	1 yr.	38-1/4 x 17 x 29-1/8	97.0 x 43.2 x 74.0	10.9	0.3
PF3033HL	33" Multi-Fire XD™ Electric Firebox - Realogs™	60 / 27.2	781052 094857	1 yr.	38-1/4 x 17 x 29-1/8	97.0 x 43.2 x 74.0	10.9	0.3

Specifications, finishes and dimensions are subject to change. <sup>†</sup>Limited warranty. ©2016 Dimplex North America Limited.

SE-150-R02-111016

\* Based on national average residential electricity rate. Rates vary.