



## Opti-myst® Pro 500 Built-in Electric Cassette

CDFI500P

Design with fire,  
not limitations.



Image courtesy of  
HI Connect 2016

Picture the perfect fireplace: any length, any location, and any number of sides. Forget about venting, gas lines and hot glass, because they are a thing of the past. Now imagine flames made of water that you can reach out and touch. The revolutionary Opti-myst by Dimplex reinvents the electric fireplace and makes it easier than ever to add a dramatic fire feature to any space. See-through, three-sided, open concept, the possibilities are endless, so go ahead, play with fire.

**Dimplex®**



# Opti-myst® Pro 500

## Built-in Electric Cassette

CDFI500P

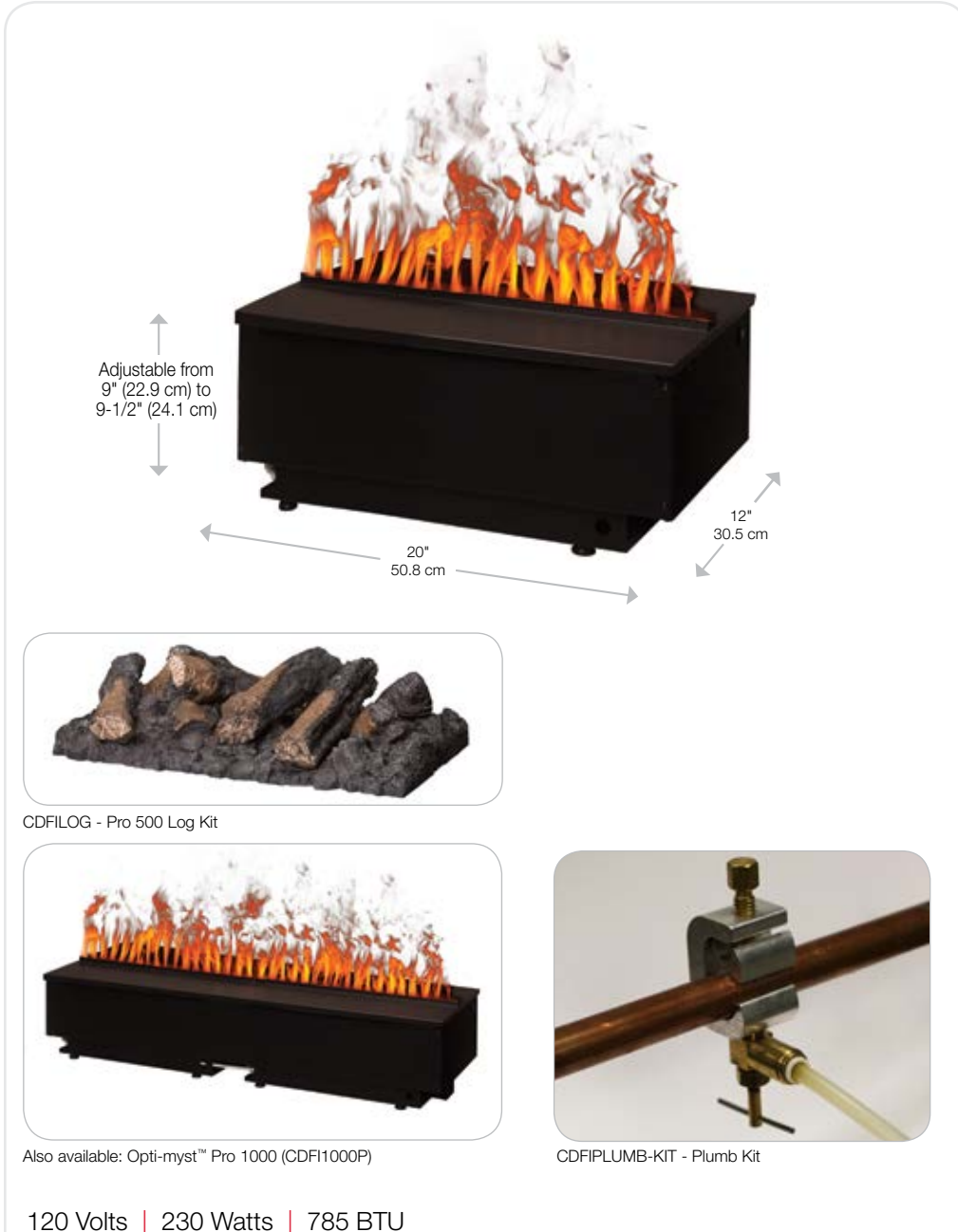

120 Volts | 230 Watts | 785 BTU











Model #	Description	Lbs/Kg	UPC	Wty.	Carton Dimensions (WxHxD)		Cube	
					inches	cm	Ft³	M³
CDFI500P	Opti-myst® Pro 500 Cassette	24.2 / 10.9	781052 105584	2 yr.	24-3/8 x 13-7/8 x 17-3/4	62.0 x 34.0 x 45.0	8.8	0.09
CDFILOG	Pro 500 Log Kit	28 / 12.7	781052 103238		23-1/2 x 11 x 17-1/5	59.7 x 27.9 x 44.5	2.62	0.07
CDFIPLUMB-KIT	Plumb Kit	0.7 / .32	781052 103221		15-1/2 x 3-1/2 x 6-1/2	39.4 x 8.9 x 16.5	0.20	0.01
CDFI-PLUGKIT	Plug Kit	TBD	781052 105591		11-1/4 x 3-1/4 x 4	28.7 x 8.1 x 10.2	0.08	0.00

Specifications, finishes and dimensions are subject to change. \*Limited warranty. ©2016 Dimplex North America Limited.

SE-009-R04-101716

Dimplex North America Limited | 1367 Industrial Rd., Cambridge ON, Canada N3H 4W3 | 1-800-668-6663 | www.dimplex.com

### Features

-  **Opti-myst® Flame Effect**  
Revolutionary ultrasonic technology produces a fine mist to create the illusion of flames and smoke.
-  **Customization**  
Multiple 20" (50.8 cm) and 40" (101.8 cm) cassettes can be combined in series to achieve the desired length for dramatic linear installations impossible to achieve with gas fires.
-  **Adjustable Flame**  
Control the desired volume of flame to suit.
-  **Continuous Water Supply**  
Optional plumbed water supply kit provides continuous operation without refilling water tanks.
-  **All-day Flames**  
Fill the water tank with tap water and enjoy up to 8 hours of continuous flames.
-  **Media Options**  
Includes flat plate that can be customized with contemporary media (not included). Optional inner glow logs also available.
-  **Crackling Sound Effects**  
Enjoy a more complete sensory experience with the sound of natural wood fire.
-  **Frame, Wire and Finish**  
Basic installation requires fewer tradespeople, no gas lines, venting or chimney.
-  **Zero Emissions**  
The most sustainable fireplace option; no emissions and 100% efficient.
-  **Energy Efficient**  
Uses low-energy LED lights for low-cost operation.
-  **Heat-free Operation**  
Designed with the sole purpose of providing a stunning visual flame feature.
-  **Sight and Sound Remote**  
Control the flames and crackling sound effects at the touch of a button.



# Opti-myst® Pro 500

## Built-in Electric Cassette

CDFI500P

### Product Dimensions:

#### MEDIA PLATE

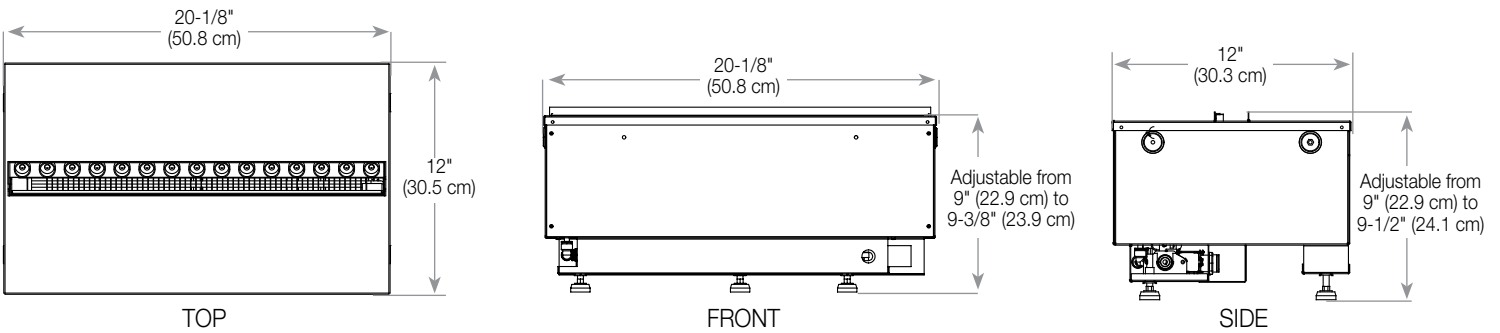

#### LOG SET

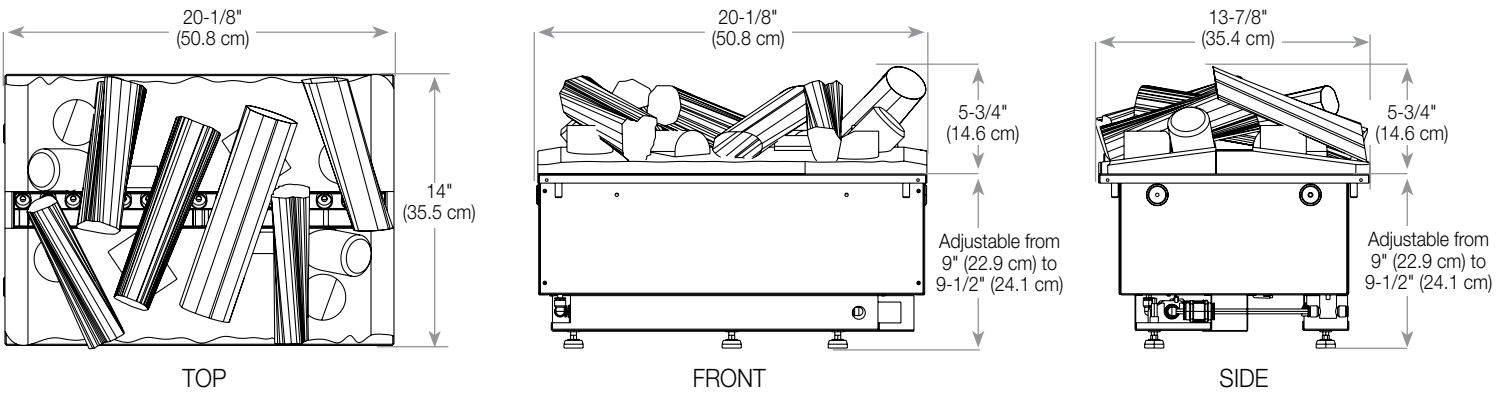

### Framing Dimensions

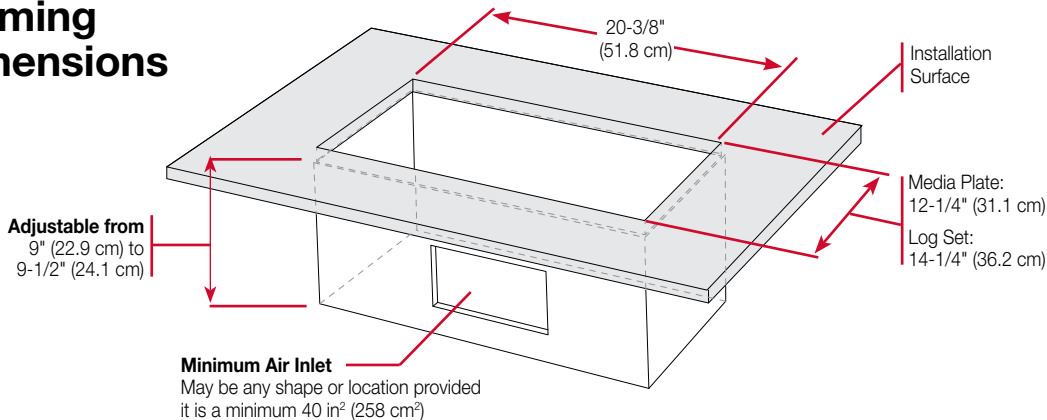

**Caution:** When determining a location for the Opti-myst® cassette, ensure that the unit will not be susceptible to drafts, vents, ceiling fans and other air currents. Similar to a candle, large movements of air will affect the unit's ability to create and maintain the flame effect.