

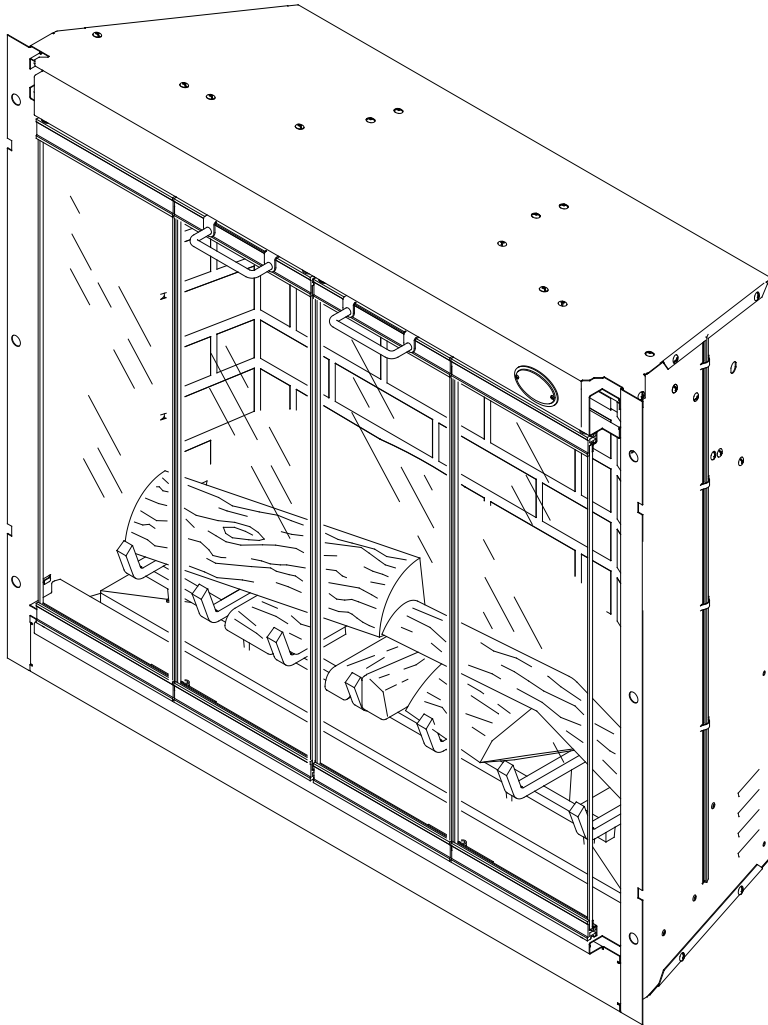

Better solutions through innovation



# Service Manual

## 32" Purifire Fireplace

Model Numbers:  
**DF3215**

**IMPORTANT SAFETY INFORMATION:** Always read this manual first before attempting to service this fireplace. For your safety, always comply with all warnings and safety instructions contained in this manual to prevent personal injury or property damage.

**Dimplex North America Limited**  
1367 Industrial Road • Cambridge ON Canada N1R 7G8  
1-888-346-7539 • [www.dimplex.com](http://www.dimplex.com)

In keeping with our policy of continuous product development, we reserve the right to make changes without notice.  
© 2014 Dimplex North America Limited

REV	PCN	DATE
00	--	Aug 22/07
01	11540	Jul 28/09
02	--	Feb 15/12
03	-	Aug 22/14

## Table of Contents

Operation . . . . .	3
Maintenance . . . . .	9
Exploded Parts Diagram . . . . .	10
Replacement Parts List . . . . .	10
Wiring Diagram . . . . .	11
Partially Reflective Glass Replacement. . . . .	12
On/Off Switch Replacement . . . . .	12
Switchboard Replacement. . . . .	13
Flicker Motor/Flicker Rod Replacement . . . . .	13
Light Harness Replacement . . . . .	14
Remote Control Replacement . . . . .	15
Heater Assembly/Cutout Replacement . . . . .	15
Power Cord Replacement . . . . .	16
Troubleshooting Guide . . . . .	18

Always use a qualified technician or service agency to repair this fireplace.

**! NOTE:** Procedures and techniques that are considered important enough to emphasize.

**⚠ CAUTION:** Procedures and techniques which, if not carefully followed, will result in damage to the equipment.

**⚠ WARNING:** Procedures and techniques which, if not carefully followed, will expose the user to the risk of fire, serious injury, or death.

# Operation

## Electric Fireplace Manual Control

The manual controls for the fireplace are located in the upper right hand corner (Figure 1).

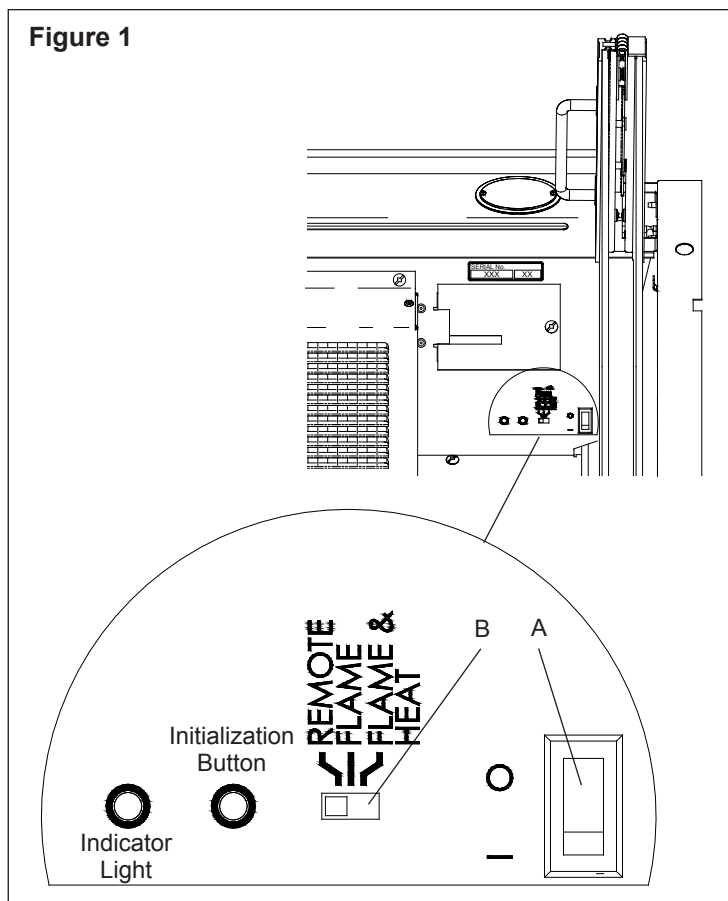

### A. On/Off Switch

The On/Off switch controls the electricity supply to the unit. When the switch is in the “ I ” position the unit is ON and when the switch is in the “ O ” position the unit is OFF.

### B. 3-Position Switch

**Remote (left position):** The unit is operated with the remote control.

**Flame (center position):** The flame effect is turned on.

**\* Flame & Heat (right position):** The flame effect and heater are turned ON simultaneously. When the manual control is in the **Flame & Heat** position the heater does not run on the remote operated thermostat. When the heater is ON the red indicator light is activated on the firebox and the fan and heater are running on low.

**! NOTE:** When the On/Off switch is in the **Flame** and **Flame & Heat** positions, the fireplace unit will not operate with the remote control.

\* **Flame only function of DF3215NH**

### Resetting The Temperature Cutoff Switch \*\*

Should the heater overheat, an automatic switch will turn the heater off and it will not come back on without being reset. The temperature cutoff switch can be reset by unplugging the unit, waiting 5 minutes and plugging the unit back in.

\*\* **Not applicable on DF3215NH model fireplaces.**

**! CAUTION:** If you need to continuously reset the heater, unplug the unit and call Dimplex North America Limited at 1-888-346-7539 for technical support.

## Remote Control - Multifire

The remote control has a range of approximately 50 ft. (15.25m). It does not have to be pointed at the fireplace and can pass through most obstacles (including walls). It is supplied with 243 independent frequencies to prevent interference with other units.

### Battery Installation

1. Depress tab on the battery cover on the back of the remote control and remove battery cover (Figure 2).
2. Install two (2) AAA batteries into the remote control (included).
3. Ensure child lock is in the “unlocked” position.
4. Replace the battery cover.



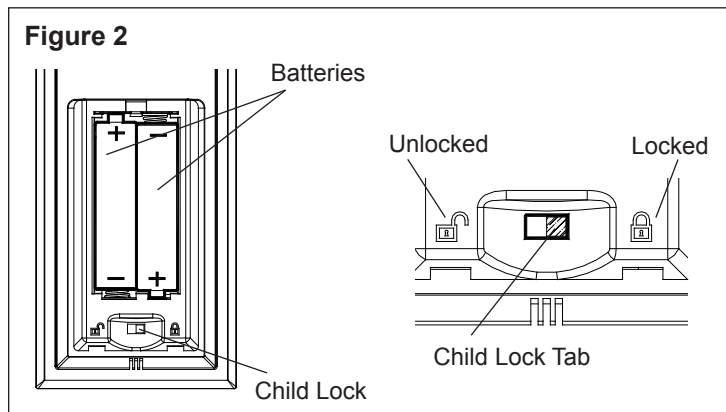

**! NOTE:** When the  symbol is present on the remote control, it is recommended to replace the batteries promptly to maintain full functionality of the remote control and fireplace. The remote control has a battery backup time of only several hours.

Batteries must be recycled or disposed of properly.

 Check with your Local Authority or Retailer for recycling advice in your area.



## Initializing/Reprogramming Remote Control

1. Plug power cord into 120 Volt wall outlet.
2. Ensure the On/Off switch, located in the switch box in the fireplace in the upper right hand corner, is in the On ( I ) position.
3. Set the 3-Position Switch to the **Remote** position (left position).
4. Press and hold the initialization button on the unit.
5. While holding the initialization button, press the Flame/Heat On/Off button  or the Purifire™ On/Off button  on the remote control.
6. Release the initialization button on the unit.
7. Press the Flame/Heat On/Off button  to turn the Flame/Heat function On, or press the Purifire™ On/Off button  to turn the Purifire™ function ON.

## Frequency Interference

If the fireplace does not respond properly to the remote

control, the remote operating frequency may need to be reset. The remote control can send another frequency code to the remote control receiver to eliminate interference.

1. Simultaneously press the “**Slow Start**” button and the “**Purifire™ Low Speed**” button on the remote control. “**CODE**” will appear, on the remote display screen.
2. Release the “**Slow Start**” button and the “**Purifire™ Low Speed**” button.
3. Press and hold the initialization button on the unit.
4. Press the  button on the remote and release the initialization button.

Your remote will now have a different frequency communicating with the fireplace.

## Remote Control Functions

(All letter references are to Figure 3)

### B - Set Temperature\*

Press **G**  button to turn the fireplace on.

Press **J** to raise thermostat.

Press **I** to lower the thermostat.

Press both **J** and **I** to change °F to °C.

\* **Not applicable on DF3215NH model fireplaces.**

### C - Upper Light Level Indicator

Press the **G**  button to turn the Flame & Heat on.

Repeatedly press the **L** or **K** button to increase or decrease the brightness of the upper lights.

To activate the **Upper Light**, continue pressing **L** until the **Upper Light On** bar icons are shown on the display screen.

To shut the **Upper Light** off continue pressing the **K** button until the **Upper Light** has no bar icons shown in the display.

### D - Flame Speed Control

Press the **G** button to turn the Flame & Heat on.

Press the **N** button to increase the speed of the flame.

Press the **M** button to decrease the speed of the flame.

### E - Slow Start/Fading Embers Control

The **Slow Start** function simulates a starting fire. The function is automatically programmed for 30 seconds and the timer setting cannot be changed. The **Fading Embers** function simulates a fire going out. The **Fading Embers** timer can be set to 1, 5 or 10 minutes.

Press the **P** button to turn the **Slow Start/Fading Embers** function on.

Press the **P** button repeatedly to set the **Fading Embers** timer to 1, 5 or 10 minutes.

Press the **O** button to turn the **Fading Embers** timer function off.

### F - Purifire™ Speed

When the **Purifire™** function is on, the **Purifire™** symbol will flash. When off the symbol will be solid. The default setting for the **Purifire™** is low speed.

Press the **H** button to turn the **Purifire™** function **On**.

Press the **Q** to decrease the **Purifire™** speed or the **R** to increase the speed.

Press the **H** button to turn the **Purifire™** function off.

**! NOTE:** To turn the Flame & Heat and Purifire™ off, press both control buttons simultaneously.

### G - Flame & Heat On/Off \*

Press the **G**  button to turn the Flame & Heat function on. When **B** is higher than **A** the heat will come on. To turn the heat off, lower **B** so that it's setting is lower than **A**. The default temperature setting is 72°F (22°C).

**! NOTE:** When using the remote control the heater runs on a thermostat. Press the **J** or **I** button to adjust **B**. Once the desired set temperature is reached the heater will turn off. The heater will cycle on and off to maintain the desired set temperature.

\* **Not applicable on DF3215NH model fireplaces.**

### Disable Heat

If desired, depending on the season, the heater on the unit can be disabled. The remainder of the controls will operate in the same fashion.

*To Disable* - Press **J** and **O** at the same time. The

Figure 3

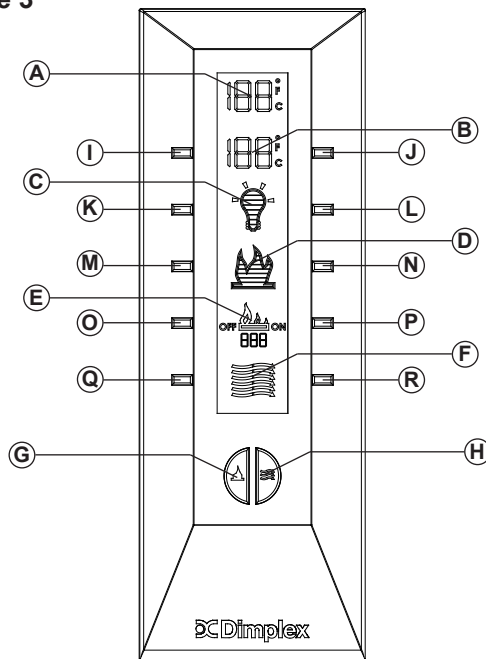

- |                                      |   |
|--------------------------------------|---|
| A - Room Temperature                 | J - Temperature Up*                         |
| B - Set Temperature*                 | K - Upper Light Dimmer Down                 |
| C - Upper Light Level Indicator      | L - Upper Light Dimmer Up                   |
| D - Flame Speed Control              | M - Flame Speed Down                        |
| E - Slow Start/Fading Embers Control | N - Flame Speed Up                          |
| F - Purifire™ Speed                  | O - Slow Start/Fading Embers Off            |
| G - Flame & Heat On/Off              | P - Slow Start/Fading Embers On/Timer Cycle |
| H - Purifire™ On/Off                 | Q - Purifire™ Low Speed                     |
| I - Temperature Down*                | R - Purifire™ High Speed                    |

\* The set temperature buttons are not operational on the DF3215NH model fireplaces.

temperature setting on the remote will no longer be visible.

**! NOTE:** The heat will not work in manual controls either. To Enable - Press **J** and **Q** at the same time. The temperature setting will now be visible again.

### Child Lock

1. Depress tab on the battery cover on the back of the remote control and remove the battery cover (Figure 2).
2. Move **Child Lock** tab to the right to lock the remote control.
3. Move **Child Lock** tab back to the left to unlock the remote control.
4. Replace the battery cover.

**! NOTE:** To temporarily unlock the remote control press (in order) **I** then **J** then **K**.

When the remote control's backlight is illuminated the **Child Lock** is bypassed. When the backlight is off the **Child Lock** is re-activated.

### Remote Control - Full Feature

The remote control has a range of approximately 50 ft. (15.25m), it does not have to be pointed at the fireplace and can pass through most obstacles (including walls). It is supplied with 243 independent frequencies to prevent interference with other units.

### Battery Installation

1. Depress tab on the battery cover on the back of the remote control and remove battery cover.
2. Install 3 AAA batteries into the remote control. (Included)
3. Replace the battery cover.

**! NOTE:** The remote control has a battery backup time of 24 hours. The batteries can be removed for up to 24 hours before the remote control will require re-initialization.





**! NOTE:** When the Low Battery icon  is present on

the remote control it is recommended to replace the batteries promptly, to maintain full functionality of the remote/fireplace (Figure 4).





Batteries must be recycled or disposed of properly. Check with your Local Authority or Retailer for recycling advice in your area.

### Initializing/Reprogramming Remote Control



1. Plug power cord into 120 volt wall outlet.
2. Turn ON the electrical power at the circuit breaker.
3. Ensure the On/Off switch located inside the fireplace in the upper right hand corner is in the ON position.
4. Set the 3 position manual control to the Remote position (left position).
5. Press and hold the initialization button on the unit.
6. While holding the initialization button, press the flame/heat ON/OFF button  or the Purifire™ ON/OFF button  on the remote control.
7. Release the initialization button on the unit.
8. Press the Flame/Heat On/Off button  to turn the Flame/Heat function ON or press the Purifire™ On/Off button  button to turn the Purifire™ function ON.

### Frequency Interference

If the fireplace does not respond properly to the remote control, the remote operating frequency may need to be reset. The remote control can send another frequency code to the Remote Control Receiver to eliminate interference.

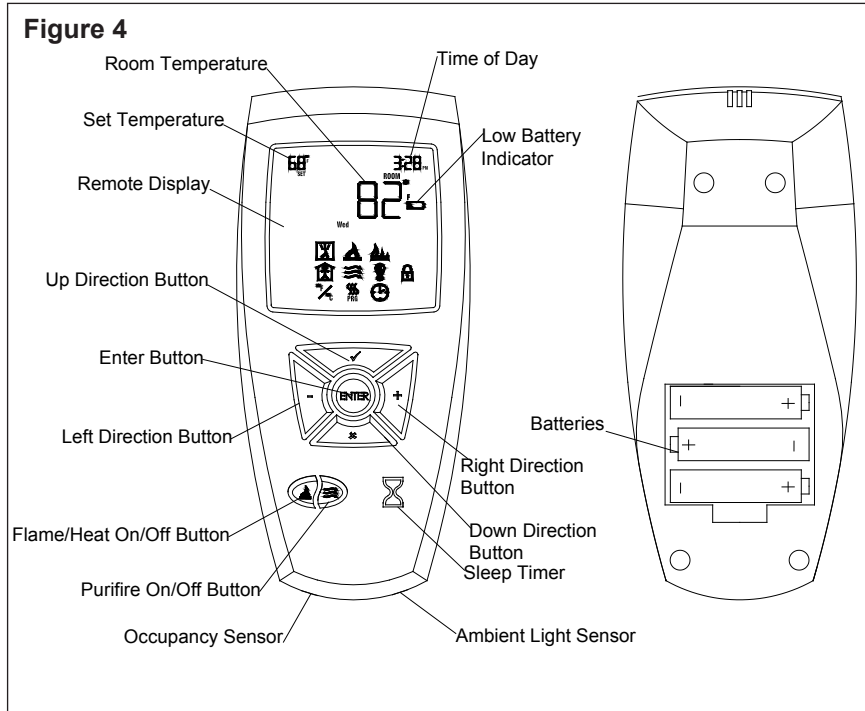



1. Press the Flame/Heat On/Off button  to turn the Flame/Heat ON.
2. Press the ENTER button on the remote control, the middle display will flash .
3. Use the direction buttons on the remote control to move the cursor to  and press ENTER.
4. Press and hold the initialization button on the unit.



5. Press and hold “-” left direction button on the remote control.
6. A descending bar graph will appear on the screen.
7. The green indicator light will flash on the unit when the new frequency code has been stored.
8. Release “-” left direction button on the remote control.
9. Release the initialization button on the unit.
10. Press ENTER to return to the main menu.
11. Press the Flame/Heat On/Off button  to turn the Flame/Heat function ON or press the Purifire™ On/Off button  to turn the Purifire™ function ON.



## Remote Control Functions



### Flame/Heat On/Off Button

Press the Flame/Heat On/Off button  to turn the Flame/Heat function ON. When the heater function is ON, the  icon is displayed on the remote control in the upper left hand corner. When this  icon is displayed, the red indicator light is activated on the firebox. The default temperature setting is 72°F (22°C). Press the Flame/Heat On/Off button  to turn the Flame/Heat function OFF.





**! NOTE:** When using the remote control the heater runs on a thermostat. Press the **+** or **-** direction keys to adjust the set temperature. Once the desired set temperature is reached the heater will turn OFF. The heater will cycle ON and OFF to maintain the desired set temperature.

### Purifire On/Off Button



Press the Purifire™ On/Off button  to turn the Purifire™ function ON. When the Purifire™ function is ON and the Heater  icon is NOT displayed on the remote control, the green indicator light is activated on the firebox. The default setting for the Purifire™ is set at low speed. Press the Purifire™ On/Off button  to turn the Purifire™ function OFF.

**! NOTE:** To turn the Flame/Heat and Purifire™ ON or OFF at the same time, press both   control buttons simultaneously.





### Setting the Clock

1. Press the ENTER button - the middle display  will flash.
2. Use the direction buttons on the remote control to move the cursor to the  clock and press the ENTER button.
3. A day of the week will flash.
4. Use the **-** left or **+** right direction button to select the day of the week.
5. Press the  up direction button and the hour display will flash.
6. Use the **-** left or **+** right direction button to select the hour.
7. Press the  up direction button and the minute display will flash.
8. Use the **-** left or **+** right direction button to select the minute.
9. Press ENTER to return to the main menu.



### Setting the Temperature

1. Press the ENTER button - the middle display  will flash.
2. Use the direction buttons on the remote control to move the cursor to  and press ENTER.
3. Use the **-** left or **+** right direction button to select between °F and °C.
4. Press ENTER to return to the main menu.



### Firelight

1. Press the Flame/Heat button  to turn the Flame/Heat ON.
2. Press the ENTER button - the middle display  will flash.
3. Use the direction buttons on the remote control to move the cursor to  and press ENTER.
4. Press the  up direction button to turn the firelight ON, press the  down direction button to turn the firelight OFF.
5. Press ENTER to return to the main menu.

### Flame Speed





1. Press the Flame/Heat button  to turn the Flame/Heat ON.
2. Press the ENTER button - the middle display  will flash.
3. Use the direction buttons on the remote control to move the cursor to  and press ENTER.
4. Repeatedly press the **-** left or **+** right direction buttons to decrease or increase the flame speed.  
**! NOTE:** The bar graph located on the top of the display screen indicates the speed range of the flame.
5. Press ENTER to return to the main menu.

### Light Dimmer

1. Press the Flame/Heat button  to turn the Flame/Heat ON.
2. Press the ENTER button - the middle display  will flash.
3. Use the direction buttons on the remote control to move the cursor to  and press ENTER.
4. Repeatedly press the **-** left or **+** right direction button to decrease or increase the brightness of the upper lights.  
**! NOTE:** The bar graph located on the top of the display screen indicates the upper light brightness range.

### Ambient Light Sensor

When the room gets darker the upper lights dim, allowing for a more desirable and realistic flame effect. The ambient light sensor is located in the bottom of the remote. (Figure 4)



1. Press the Flame/Heat button  to turn the Flame/Heat ON.
2. Press the ENTER button - the middle display  will flash.
3. Use the direction buttons on the remote control to move the cursor to  and press ENTER.
4. Press the  up direction button to turn the ambient light sensor ON. Press the  down direction button to turn

the ambient light sensor OFF.

5. Press ENTER to return to the main menu.

### Slow Start/Fading Embers



The slow start function simulates a starting fire. The slow start function timer is automatically programmed for 30 seconds. The slow start timer setting cannot be changed. The fading embers function simulates a fire going out. The fading embers function timer can be set to 1, 5, or 10 minutes.

1. Press the ENTER button - the middle display  will flash.
2. Use the direction buttons on the remote control to move the cursor to  and press ENTER.
3. Press the - left or + right direction button to select 1, 5, or 10 minutes for the fading embers.
4. Press the ✓ up direction button to turn the slow start/fading embers function ON, press the ✕ down direction button to turn the slow start/fading embers function OFF.
5. Press ENTER to return to the main menu.
6. Press the Flame/Heat on/off  button to activate the slow start/fading embers.



! **NOTE:** When turning the unit OFF with the slow start/fading ember function ON, the slow start/fading ember  indicator will flash for 1 minute.

### Occupancy Sensor

The occupancy sensor function can be programmed to turn the fireplace ON when it detects movement. The occupancy sensor is programmed to turn the fireplace OFF when it doesn't detect movement in 5, 10, or 20 minutes. The occupancy sensor is located in the bottom of the remote. (Figure 4) The occupancy sensor has a range of 10 feet.

1. Press the ENTER button - the middle display  will flash.
2. Use the direction buttons on the remote control to move the cursor to  and press ENTER.
3. Press the - left or + right direction button to 5, 10, or 20 minutes.
4. Press the ✓ up direction button to turn the occupancy sensor ON, press the ✕ down direction button to turn the occupancy sensor OFF.
5. Press ENTER to return to the main menu.

### Child Lock

1. Press the ENTER button - the middle display  will flash.
2. Use the direction buttons on the remote control to move the cursor to  and press ENTER.
3. Press and hold the ✓ up direction button for 4 – 5 seconds. The  will flash when the child lock function



has been turned ON.

4. To turn the child lock function OFF, hold the ✕ down direction button for 4 – 5 seconds.

### Purifire™



The Purifire™ includes a high efficiency filter to help improve the quality of air. When the Purifire™ function is ON and the Heater  icon is **NOT** displayed on the remote control, the green indicator light is activated on the firebox.

! **NOTE:** The red indicator light overrides the green Purifire™ light.

1. Press the ENTER button until the middle display  flashes.
  2. Press the ENTER button on the  Purifire™ function.
  3. Press the - left or + right direction button to select LOW or HIGH.
  4. Press the ✓ up direction button to turn the Purifire™ ON, press the down ✕ direction button to turn the Purifire™ OFF.
  5. Press ENTER to return to the main menu.
- ! **NOTE:** The Purifire™ can also be turned On/Off by pressing the  Purifire™ On/Off button.

### Sleep Timer

The Sleep Timer automatically shuts off the fireplace after a preset time (from 30 minutes to 8 hours).

1. To set the sleep timer press the sleep timer  button.
2. Pressing the sleep timer button repeatedly will increase the sleep timer by 30 minute increments.
3. The fireplace will automatically turn OFF when the sleep timer reaches 0 minutes.
4. The sleep timer can be cancelled at any time by pressing the sleep timer  button repeatedly until the sleep timer display disappears and the room temperature display is shown.

### Programmable Heater Setting

The heater thermostat can be programmed to suit your individual needs by using the INDIVIDUAL DAY SETTING. When going through the programmable heater setting for the first time the display screen on the remote will read --:--. The programmable heater has 2 program settings (P1 and P2). Program 1 (P1) is to be used for your comfortable room setting and Program 2 (P2) is to be used as your set back (energy-saving) temperature. Once the heater has been programmed and the program has been turned ON the temperature can only be changed by either turning the program OFF or by pressing the Flame/Heat  On/Off button. (see programming individual day setting section to turn program OFF and/or temporary manual override section)

! **NOTE:** When the occupancy sensor function is ON, it will also override the programmable heater setting.

## Personal Program Schedule



Before programming the heater, use the personal program schedule below to determine which time and temperature settings meet your schedule.

Use a pencil to be able to revise your records each time you are required to change your program settings.

Day	Program 1 (P1)		Program 2 (P2)	
	Time	Temp	Time	Temp
Monday				
Tuesday				
Wednesday				
Thursday				
Friday				
Saturday				
Sunday				

## Temporary Manual Override







To temporarily change the current set temperature without affecting the current programs:

1. Press the Flame/Heat On/Off button  - the **PRG** display will disappear.
2. Press the **+** right or **-** left direction button to select the set temperature.
3. To cancel the temporary manual override press the Flame/Heat On/Off button  and the programmed settings will be reactivated.

## Programming Individual Day Setting

The Individual Day setting allows the user to program the heater thermostat to operate at a select time and temperature for each day of the week individually.

( **Mon Tue Wed Thu Fri Sat Sun** )

1. Press the ENTER button - the middle display  will flash.
2. Use the direction buttons on the remote control to move the cursor to .
3. Press and hold ENTER for 4 – 5 seconds. **Mon** display will flash.
4. Press the **+** right or **-** left direction button to select the day of the week. ( **Mon Tue Wed Thu Fri Sat Sun** )
5. Press the  up direction button and the hour display to flash.
6. Press the **+** right or **-** left direction button to select the hour.
7. Press the  up direction button and the minute display will flash.
8. Press the **+** right or **-** left direction button to select the minute.
9. Press the  up direction button and the set temperature display will flash.
10. Press the **+** right or **-** left direction button to select the temperature setting.
11. Press the  up direction button and the P1 indicator will

change to P2 and the hour display will flash.



12. Repeat steps 5 – 10 for the P2 setting.
  13. Press the  up direction button and the individual day programmed will flash.
  14. Press the **+** right direction button for each additional required program day.
  15. Repeat steps 5 – 14 for the remaining individual days.
  16. Press ENTER.
  17. Press the  up direction button to turn the programmable heater function ON and press the  down direction button to turn the programmable heater function OFF.
  18. Press ENTER to return to the main menu.
- ! NOTE:** When programmable heater function is ON the red indicator light is illuminated on the firebox and the **PRG** display will appear on the remote control.
- ! NOTE:** Press the ENTER button at any time to exit and return to the main menu.

Figure 5

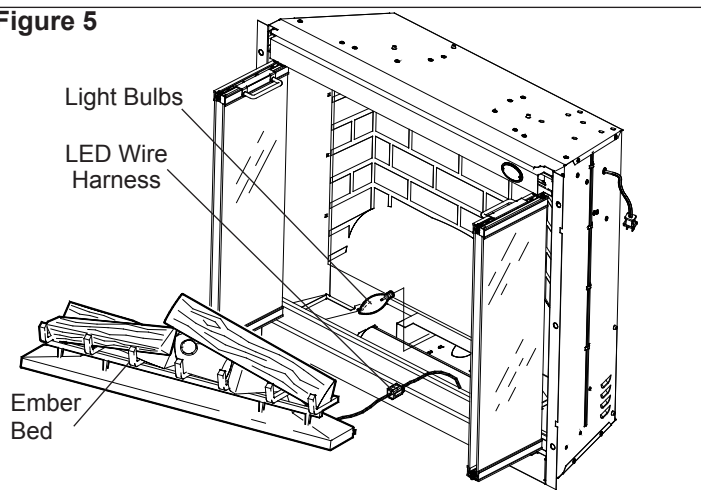

Figure 6

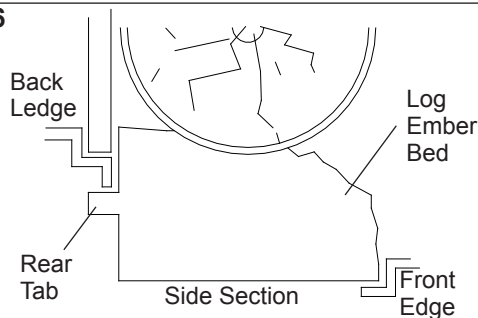
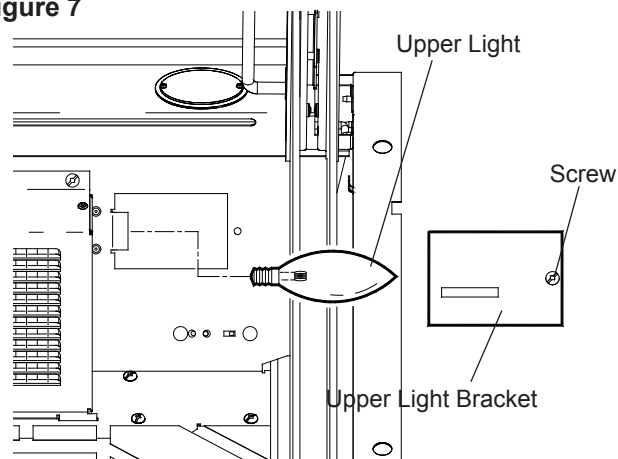

Figure 7





## Maintenance

**⚠ WARNING:** Disconnect power before attempting any maintenance or cleaning to reduce the risk of fire, electric shock or damage to persons.

### Light Bulb Replacement

Allow at least five (5) minutes for light bulbs to cool before touching bulbs to avoid accidental burning of skin.

Light bulbs need to be replaced when you notice a dark section of the flame or when the clarity and detail of the log ember bed exterior disappears. There are four (4) bulbs under the log set, which generate the flames and embers, and two (2) bulbs above the log that illuminate the log exterior.

### Lower Light Bulb Requirements

Quantity of four (4) clear chandelier or candelabra bulbs with an E-12 (small) socket base, 60 Watt rating. Example: GE 60BC or Philips 60 CTC. **Do not exceed 60 Watts per bulb.**

**Helpful Hints:** It is a good idea to replace all light bulbs at one time if they are close to the end of their rated life. Group replacement will reduce the number of times you need to open the unit to replace light bulbs. Care must be taken when removing the Log Set as the Log Set contains LED's and wires.

#### To access the lower light bulb area (Figure 5):

1. Open the Bi-fold doors.
2. Pull the front edge of the plastic Ember Bed or plastic grate up and forward until the rear tab releases from the ledge located at the bottom of the Partially Reflective Glass.

**! IMPORTANT:** Only handle the Log Set by the Ember Bed.

**! NOTE:** Log Set fits tightly into firebox. Some force may be necessary to remove.

3. Set Log Set in front of firebox.
4. Disconnect the Log Set LED wire harness from unit.
5. Lift the left side of the flicker rod out of the mounting bracket.
6. Examine the bulbs to determine which bulbs require replacement.
7. Unscrew bulbs counter clockwise.
8. Insert new bulbs.
9. Install the left side of the flicker rod into the mounting bracket.
10. Reconnect the Log Set LED Wire Harness.
11. Replace the Log Set by inserting the rear tab of the Ember Bed under the Partially Reflective Glass and pushing down on the front edge of the Ember Bed until it snaps into place (Figure 6).

**! NOTE:** Ensure the Log Set is installed tightly under the back ledge to prevent light leakage.

12. Close the Bi-fold doors.

### Upper Light Bulb Requirements

Quantity of two (2) clear chandelier or candelabra bulbs with an E-12 (small) socket base, 25 Watt rating. **Do not exceed 25 Watts per bulb.**

#### To access the upper light bulb area:

1. Open the Bi-fold doors.
2. Remove upper light bracket with a screwdriver (Figure 7)
3. Replace bulb.
4. Reassemble in the reverse order as above.

### Purifire™ Filter (Figure 8)

The Purifire™ filter supplied in your fireplace is reusable and washable. The filter should be cleaned or replaced on average once a year.

To clean the filter, gently tap filter on a hard surface to dislodge any loose dirt or debris, then clean with water. No soap or cleaning products are recommended. The filter size is 20 inches x 10 inches x 1 inch rated at MERV 10. If using an after market filter follow the manufacturers recommended replacement instructions.

#### To replace filter:

1. Open the Bi-fold doors.
2. Remove the three (3) mounting screws from the Air Filter Bracket.
3. Remove the Air Filter Bracket assembly from the firebox.
4. Slide Filter out of Air Filter Bracket.
5. Replace filter and reassemble in reverse order as above.

**! NOTE:** If after market air filter is used ensure it is installed according to the manufacturer's recommended instructions.

### Glass Cleaning

The glass is cleaned in the factory during the assembly operation. During shipment, installation, handling, etc., the glass may collect dust particles, these can be removed by dusting lightly with a clean, dry cloth.

To remove fingerprints or other marks, the glass can be cleaned with a damp cloth. To prevent scratching, do not use abrasive cleaners or spray liquids on the glass surface.

### Fireplace Surface Cleaning

Use a cloth dampened with warm water only to clean painted surfaces of the electric fireplace. Do not use abrasive cleaners.

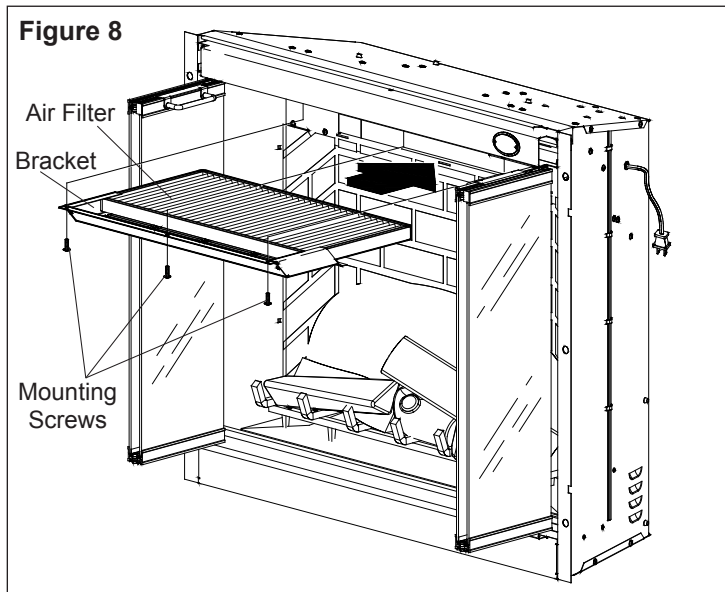

# Exploded Parts Diagram

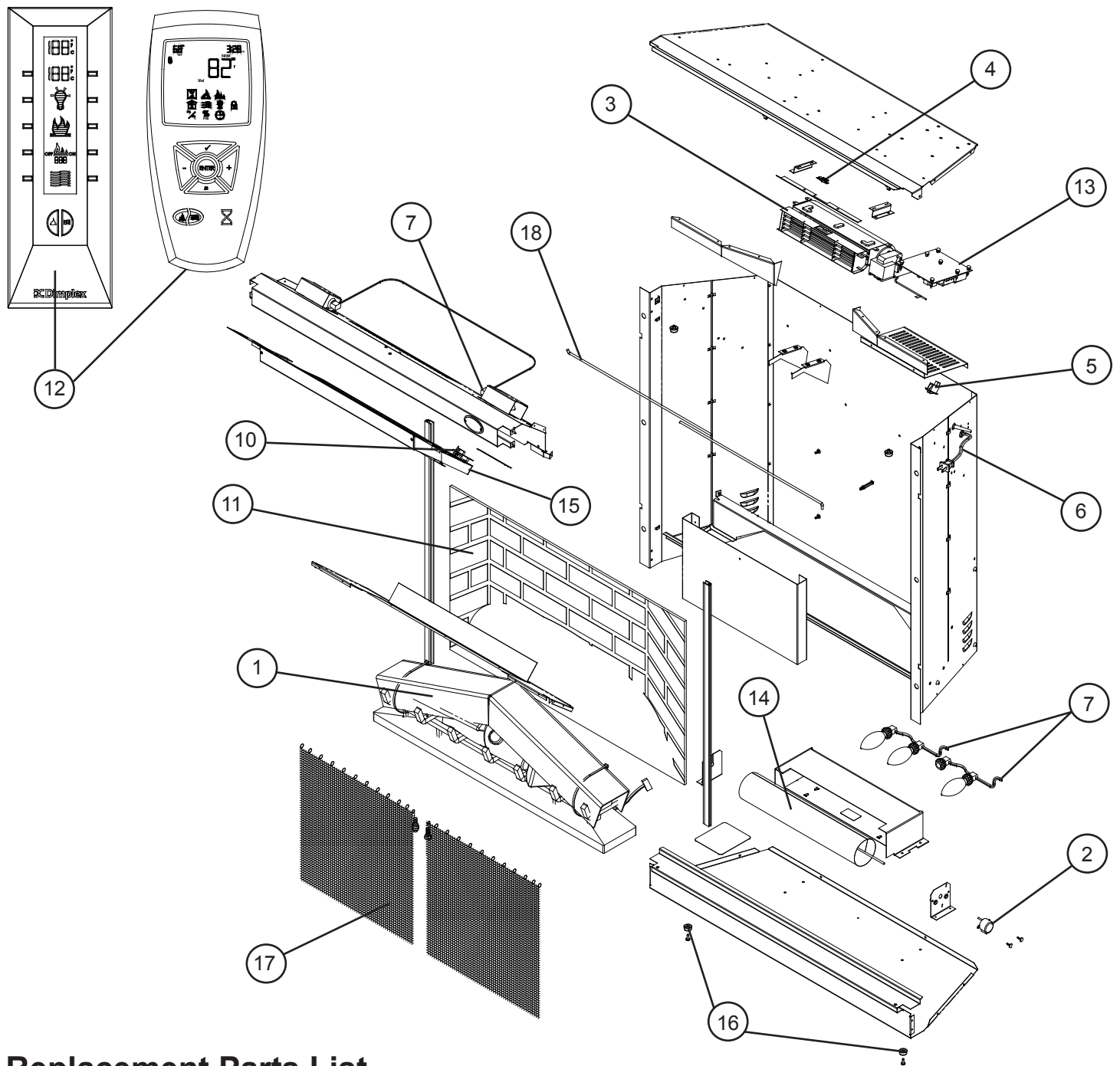

## Replacement Parts List

### Replacement Part:

1. 30" Urethane Log set . . . . .	.0439070100RP	12. Remote Control - Pre-2008 . . . . .	.3000320400RP
2. Flicker Motor . . . . .	.3000240200KIT	- Post 2008 . . . . .	.3000610100RP
3. Heater Assembly . . . . .	.2200490600RP	13. Remote Control Receiver - Pre-2008 . . . . .	.3000320200RP
4. Cutout . . . . .	.2300200500RP	- Post 2008 . . . . .	.3000320500RP
5. On/Off Switch . . . . .	.2800070700RP	14. Flicker Rod . . . . .	.5900080700RP
6. Power Cord . . . . .	.4100040400RP	15. Purifire™ Filter . . . . .	.0439060100RP
7. Upper & Lower Light Wire Assembly . . . . .	.2500200200RP	16. Fireplace Foot . . . . .	.8800090100RP
8. Wire Harness - Receiver to Log set . . . . .	.2500380100RP	17. Steel Curtain . . . . .	.8800240603RP
9. Wire Harness - Receiver to Blower . . . . .	.2500390100RP	18. Steel Curtain Rod . . . . .	.8800250400RP
10. Switchboard . . . . .	.3000320300RP	19. Bi-fold Doors Kit . . . . .	.6902560100RP
11. Partially Reflective Glass . . . . .	.5900160700RP	20. Bi-fold Door Replacement Pivot Kit . . . . .	.9600330100RP

# Wiring Diagram

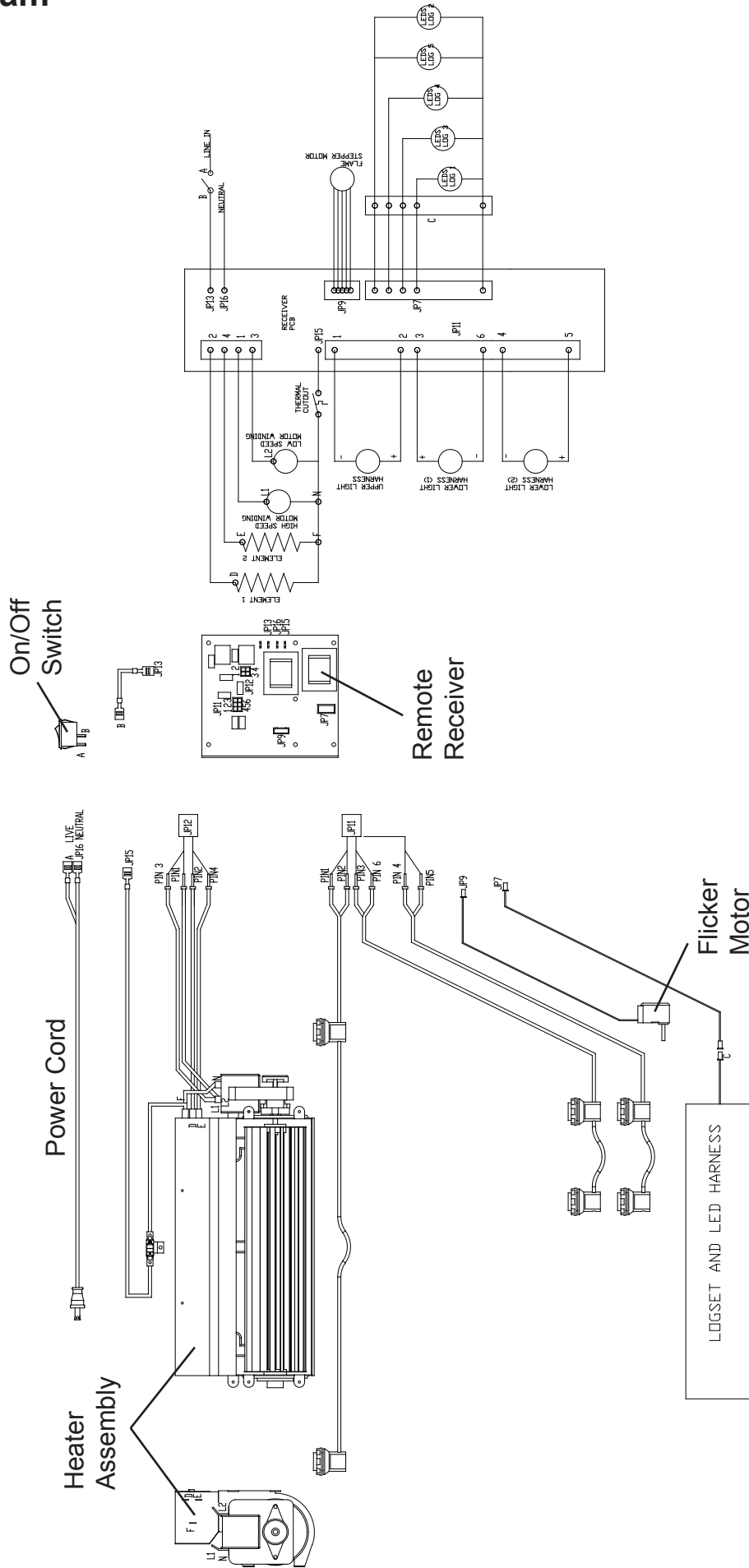

# Partially Reflective Glass Replacement

**Tools Required:** Phillips Head Screwdriver

**CAUTION:** If unit was operating prior to servicing allow at least 10 minutes for lights, heating elements and top panel to cool off to avoid accidental burning of skin.

**WARNING:** Disconnect power before attempting any maintenance to reduce the risk of electric shock or damage to persons.

1. Slide fireplace out from mantel.
2. Lay fireplace on its back.
3. Remove the 10 Philips screws that attach the bottom panel to the fireplace as shown in Figure 9. There are: two (2) screws along the bottom edge of each side; two (2) screws immediately behind the front trim piece, on each side; and two (2) screws along the back, bottom edge of the fireplace.

**NOTE:** Use caution when removing bottom panel as there are components attached to the panel which are hard wired within the fireplace chassis.

**NOTE:** The bi-fold doors are supported by the bottom panel. When pulling the bottom panel away from the chassis, do so carefully so that the doors do not get damaged.

4. Carefully remove bottom panel from fireplace and swivel it outwards to the right so as to keep wiring connected but allowing sufficient room to work.
  5. Slide the bi-fold doors out of the top frame track and set aside.
  6. Disconnect the log set LED wire harness.
  7. Remove the six (6) Philips screws that hold the log set support bracket in place. Refer to Figure 10 for a side view of the fireplace showing screw locations.
- NOTE:** Some fireplaces have these three points riveted, if this is the case, use a 1/8 inch drill bit to drill out the rivet.
8. Remove the log set and set aside.
  9. Referring to Figure 11, the sides of the log set support bracket are aligned within the rubber extrusions of the fireplace. Slide the bracket directly out the bottom of the fireplace and set aside.
  10. Slide Partially reflective glass down and out the bottom of the fireplace.
  11. Align sides of replacement Partially reflective glass with grooves of rubber extrusions and with brick effect facing out towards the front of the fireplace, slide Partially reflective glass up into the fireplace. The Partially reflective glass should slide into a holding track just beneath the filter.

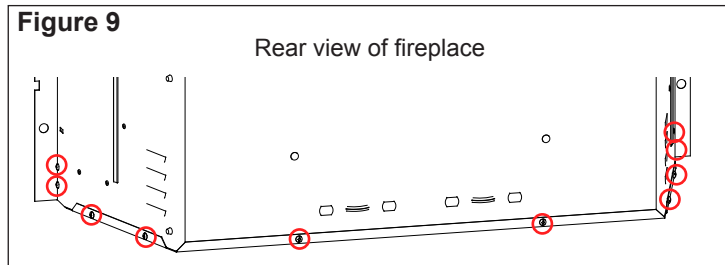

12. Slide Log Set Support Bracket back into place, the sides of the bracket line up with the grooves of the rubber extrusions (Figure 11).
13. Reinstall Log Set while support bracket is loose within fireplace. The back edge of the Log Set should fit under the bottom edge of the Partially reflective glass, and the front edge of the Log Set should fit in behind the top, inside edge of the Log Set Support Bracket (Figure 6).
14. Install Log Set Support Bracket using the six (6) screws from step 7 (or, if rivets were originally in place, use the screws supplied with RP kit for Partially reflective glass).
15. Reconnect the LED Wire Harness for the Log Set.
16. Reassemble the bottom panel of the fireplace following steps 1-5 in reverse order.

# On/Off Switch Replacement

**Tools Required:** Phillips Head Screwdriver

**CAUTION:** If unit was operating prior to servicing allow at least 10 minutes for lights, heating elements and top panel to cool off to avoid accidental burning of skin.

**WARNING:** Disconnect power before attempting any maintenance to reduce the risk of electric shock or damage to persons.

1. Remove the firebox from the mantel.
2. Remove the eight (8) Philips screws that fasten the top cover to the rest of the firebox. There are: three (3) screws on each side along the top edge; and two (2) screws on the back along the top edge (Figure 12).

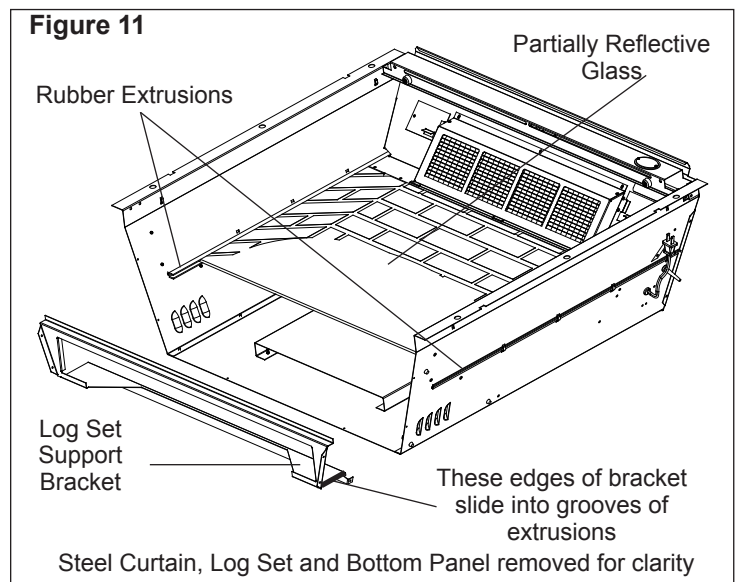
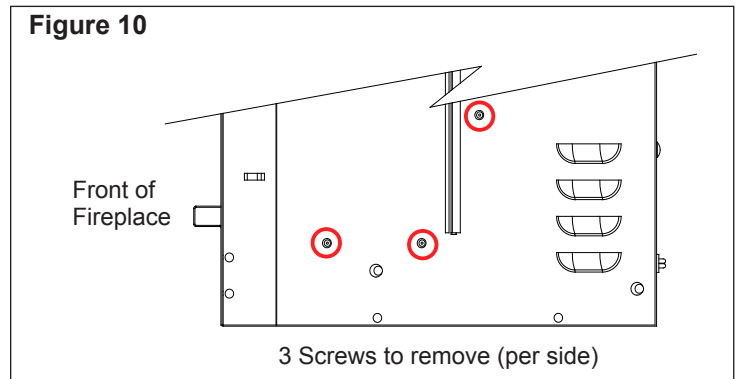

3. Flip the top panel over and rest it on the top of the fireplace.
- ⚠ CAUTION:** Use caution when flipping top panel over as there are components attached to the top panel which are wired to the internal cavity of the fireplace.
4. Open the bi-fold doors and steel curtain.
  5. Locate the On/Off Switch mounted on the top of the fireplace on the right side (Figure 13) and disconnect the two (2) wiring clips, noting their original locations.
  6. Depress the two (2) retainer clips on the sides of the switch and push the switch through the sheet metal and into the fireplace display cavity. Remove from the front of the fireplace
  7. Properly orient the new switch and push it through the sheet metal from inside the firebox. Push until the retainer clips on either side of the switch snap into place.
  8. Re-connect the two (2) wire clips to the back of the switch.
  9. Reassemble in the reverse order as above.

## Switchboard Replacement

**Tools Required:** Phillips Head Screwdriver

**⚠ CAUTION:** If unit was operating prior to servicing allow at least 10 minutes for lights, heating elements and top panel to cool off to avoid accidental burning of skin.

**⚠ WARNING:** Disconnect power before attempting any maintenance to reduce the risk of electric shock or damage to persons.

1. Remove the firebox from the mantel.
  2. Remove the eight (8) Philips screws that fasten the top cover to the rest of the firebox. There are: three (3) screws on each side along the top edge; and two (2) screws on the back along the top edge (Figure 12).
  3. Flip the top panel over and rest it on the top of the fireplace.
- ⚠ CAUTION:** Use caution when flipping top panel over as there are components attached to the top panel which are wired to the internal cavity of the fireplace.
4. Open the bi-fold doors and steel curtain.
  5. Locate the Switchboard mounted on the top of the

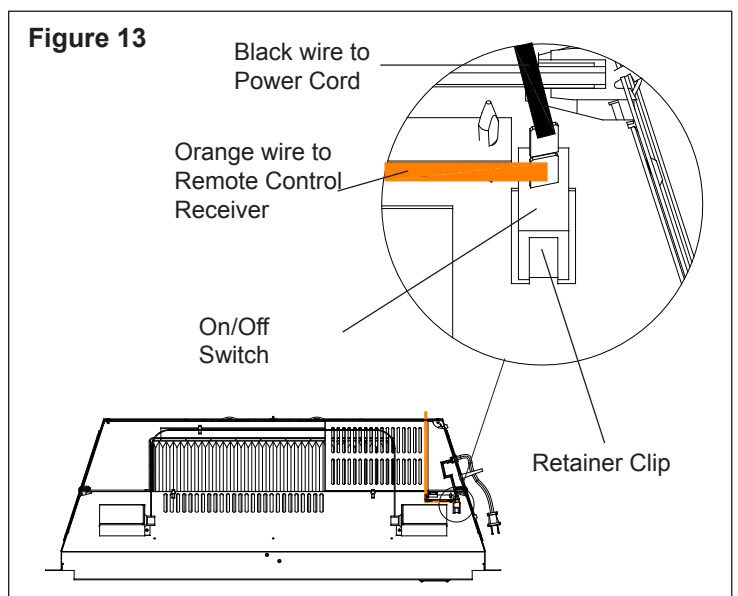
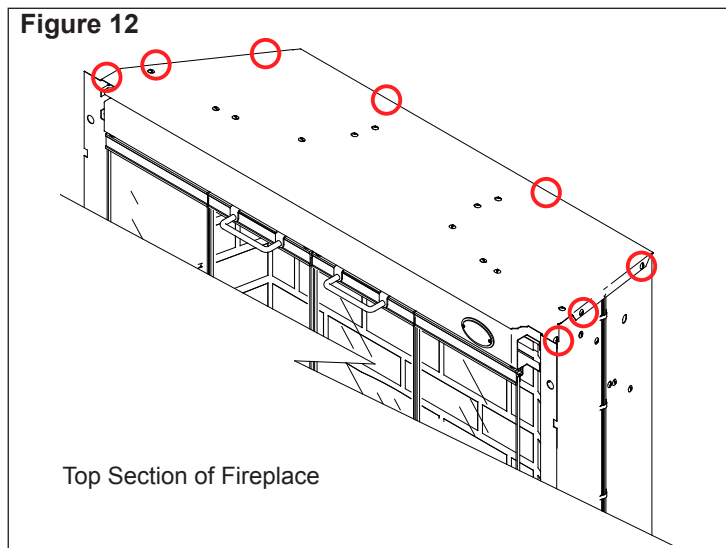

fireplace on the right side (Figure 14) and disconnect the one (1) wide white ribbon cable, noting its original location.

6. The Switchboard is fastened to the sheet metal by two (2) mounting studs, one on each side (Figure 14). Squeeze both mounting studs clasps to release and remove the Switchboard.
7. Properly orient the new Switchboard. Snap onto the mounting studs and reconnect the ribbon cable as before.
8. Reassemble in the reverse order as above.

## Flicker Motor/Flicker Rod Replacement

**Tools Required:** Phillips Head Screwdriver

**⚠ CAUTION:** If unit was operating prior to servicing allow at least 10 minutes for lights, heating elements and top panel to cool off to avoid accidental burning of skin.

**⚠ WARNING:** Disconnect power before attempting any maintenance to reduce the risk of electric shock or damage to persons.

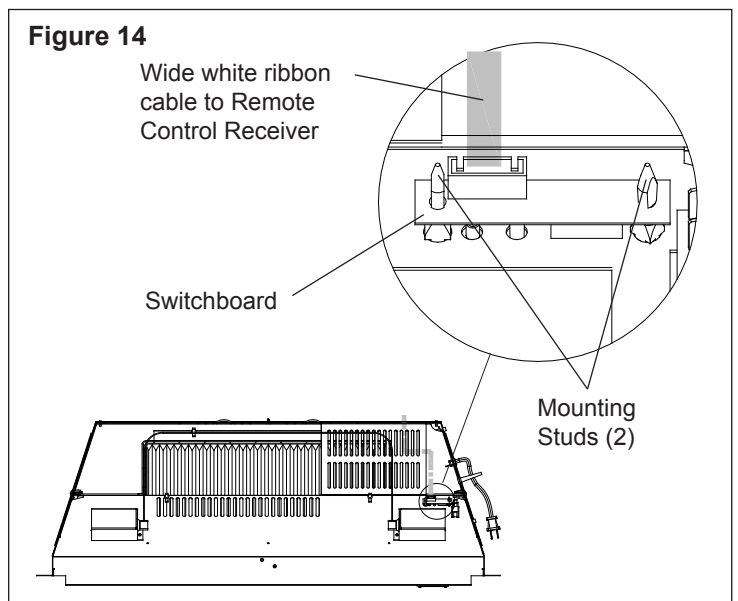

1. Slide fireplace out from mantel.
  2. Open the bi-fold doors and steel curtain.
  3. Pull the front edge of the plastic ember bed or plastic grate up and forward until the rear tab releases from the ledge located at the bottom of the partially reflective glass (Figure 6).
- ! IMPORTANT:** Only handle the log set by the ember bed.
- ! NOTE:** Log set fits tightly into firebox, some force may be necessary to remove.
4. Set log set in front of fireplace.
  5. Disconnect the log set LED wire harness from unit (Figure 5).
  6. Pull the Flicker Rod to the far right, then bend it carefully to free and lift the left side out of the mounting bracket (Figure 15).
- ! NOTE:** When removing the Flicker Rod, damage may occur if bent excessively. If the Flicker Rod is damaged, replace to insure proper operation.
7. Remove Flicker Rod (replace and reassemble if Flicker Motor does not need to be changed at this point).
  8. Before removing the Flicker Motor, cut the Flicker Motor wires (five (5) in total) close to the Flicker Motor end with wire cutters.
  9. Remove the rubber bushing from the motor shaft by applying needle nose pliers to the motor shaft and twist the rubber bushing off of the motor shaft.
  10. Remove the motor by unscrewing the two (2) Philips screws that attach the motor to the mounting bracket (Figure 15).
  11. Discard old Flicker Motor.
  12. Pick up new Flicker Motor and cut wire leads to 3 1/2 inch long with wire cutters.
  13. Using one of the supplied wire connectors from the Replacement Part Kit, place one (1) yellow wire from the new Flicker Motor and the yellow wire cut in step 9 into each terminal.
  14. Secure the wire connector by crimping the 3M symbol with pliers.

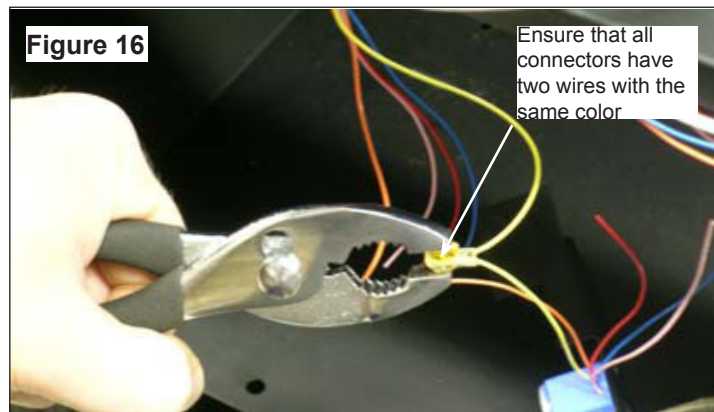
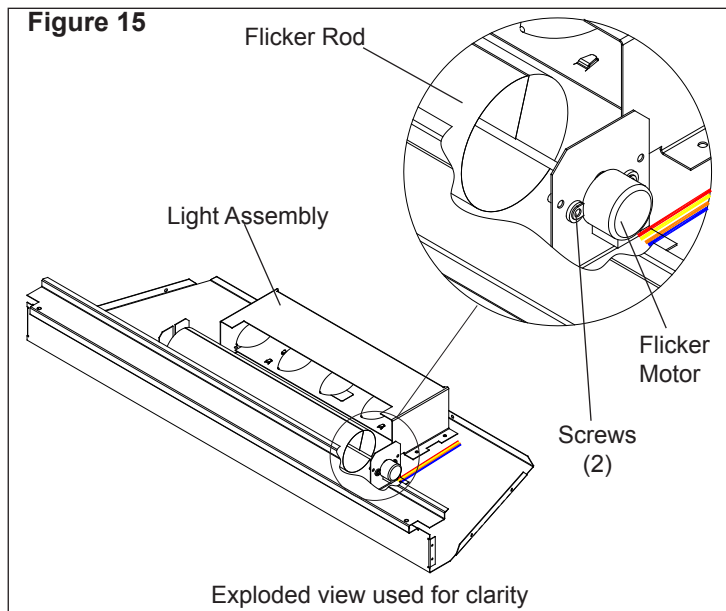

15. Pull on end of wires to ensure a strong connection.
16. Repeat the process for the four (4) remaining wires. ENSURE THAT ALL WIRES ARE PAIRED BY COLOUR IN EACH CONNECTOR.
17. Properly orient and secure the replacement Flicker Motor to the bracket with screws removed in step 10.
18. Replace rubber bushing on motor shaft.
19. Replace Flicker Rod.
20. Reassemble firebox in reverse order as above and replace in mantel.

## Light Harness Replacement

**Tools Required:** Phillips Head Screwdriver

**! CAUTION:** If unit was operating prior to servicing allow at least 10 minutes for lights, heating elements and top panel to cool off to avoid accidental burning of skin.

**! WARNING:** Disconnect power before attempting any maintenance to reduce the risk of electric shock or damage to persons.

1. Slide fireplace out from mantel.
2. Lay fireplace on its back.
3. Remove the 10 Philips screws that attach the bottom panel to the fireplace as shown in Figure 9. There are: two (2) screws along the bottom edge of each side; two (2) screws immediately behind the front trim piece, on each side; and two (2) screws along the back, bottom edge of the fireplace.

**! NOTE:** Use caution when removing bottom panel as there are components attached to the panel which are hard wired within the fireplace chassis.

- ! NOTE:** The bi-fold doors are supported by the bottom panel. When pulling the bottom panel away from the chassis, do so carefully so that the doors do not get damaged.
4. Carefully remove bottom panel from fireplace and swivel it outwards to the right so as to keep wiring connected but allowing sufficient room to work.
  5. Slide the bi-fold doors out of the top frame track and set aside.
  6. Disconnect the log set LED wire harness.
  7. Remove the 4 screws that secure the light assembly to the bottom pane. (Figure 15)
  8. Remove the light bulbs and place in a safe place.

9. Remove the ring at the base of each light harness that secures the harness to the assembly.
10. Cut and strip the light assembly wires that run to the top of the firebox.
11. Cut and strip the new light assembly wires.
12. Using the provided wire connectors connect the existing wires from the top of the firebox to the stripped wires of the new light assembly.
13. Reassembly the firebox in the reverse order as above and replace in the mantel.

## Remote Control Replacement

Remote Controls require no replacement procedure, however, a re-initialization procedure may need to be followed. Refer to Page 3 for the Remote Initialization procedure.

**Tools Required:** Phillips Head Screwdriver

**⚠ CAUTION:** If unit was operating prior to servicing allow at least 10 minutes for lights, heating elements and top panel to cool off to avoid accidental burning of skin.

**⚠ WARNING:** Disconnect power before attempting any maintenance to reduce the risk of electric shock or damage to persons.

1. Remove the firebox from the mantel.
2. Remove the eight (8) Philips screws that fasten the top cover to the rest of the firebox. There are: three (3) screws on each side along the top edge; and two (2) screws on the back along the top edge (Figure 12).
3. Flip the top panel over and rest it on the top of the fireplace.

**⚠ CAUTION:** Use caution when flipping top panel over as there are components attached to the top panel which are wired to the internal cavity of the fireplace.

4. Locate the Remote Control Receiver on the right side of the upturned top panel (Figure 17).
5. Remove the one (1) white, one (1) orange, one (1) black wire lead, four (4) cable connectors and the one (1) white ribbon cable from the Remote Control Receiver as shown in Figure 17, noting their original locations. The four (4) cable connectors all use different sized plugs, reinstallation will not be difficult.

**! NOTE:** The Antenna Wire is permanently attached to the fixed daughter card of the Remote Control Receiver (Figure 17). Do not attempt to remove.

6. The Remote Control Receiver is fastened to the underside of the top panel by seven (7) Mounting Studs, one (1) in each corner, and three (3) down off center as shown in Figure 16. Either squeeze each mounting studs clasps to release, or use side cutters to cut and remove each of the Mounting Studs on the board.

**! NOTE:** If mounting studs are cut, replacement mounting studs will need to be inserted through the top panel. Replacement Mounting Studs are supplied.

7. Remove both ends of each cut Mounting Stud from the remote control receiver and the top panel.
8. Properly orient the new Remote Control Receiver. Run the Antenna Wire out the side of the fireplace as it had

been and re-connect all of the wiring connections (refer to notes taken in step 5 and Figure 16).

14. Reassemble in the reverse order as above.

## Heater Assembly/Cutout Replacement

**Tools Required:** Phillips Head Screwdriver

**⚠ CAUTION:** If unit was operating prior to servicing allow at least 10 minutes for lights, heating elements and top panel to cool off to avoid accidental burning of skin.

**⚠ WARNING:** Disconnect power before attempting any maintenance to reduce the risk of electric shock or damage to persons.

1. Remove the firebox from the mantel.
2. Remove the eight (8) Philips screws that fasten the top cover to the rest of the firebox. There are: three (3) screws on each side along the top edge; and two (2) screws on the back along the top edge (Figure 12).
3. Flip the top panel over and rest it on the top of the fireplace.

**⚠ CAUTION:** Use caution when flipping top panel over as there are components attached to the top panel which are wired to the internal cavity of the fireplace.

4. Locate the Heater Assembly in the center of the upturned

**Figure 17**

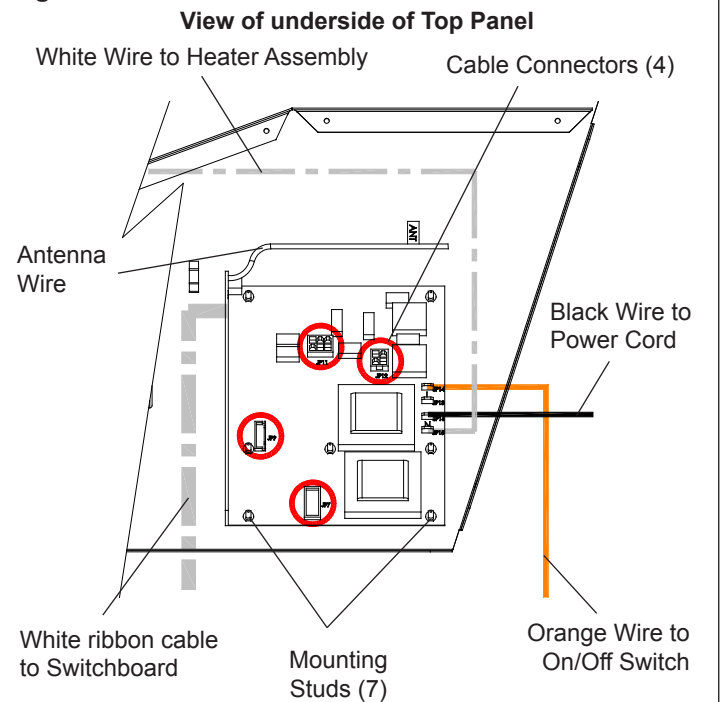

**Figure 18**

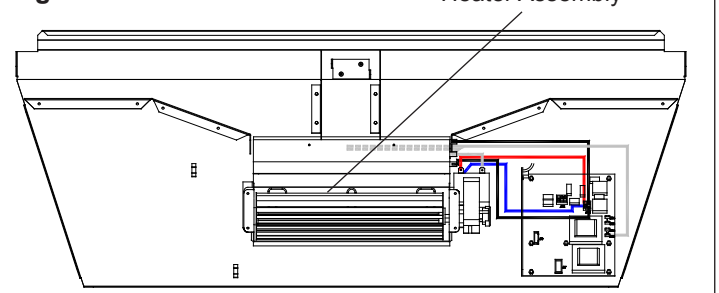

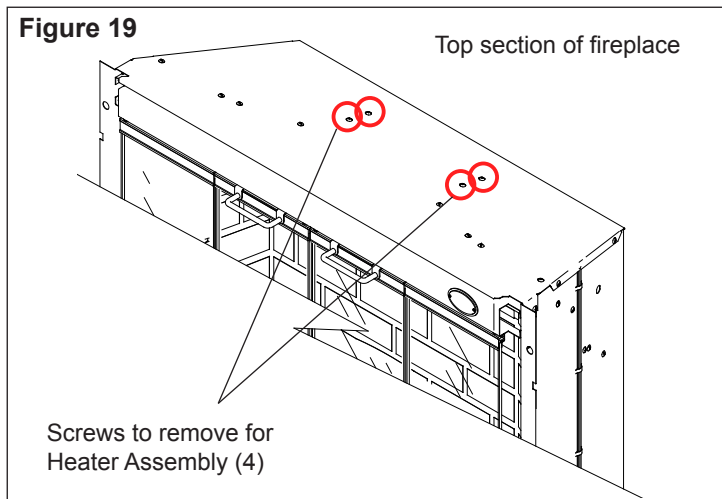
**Figure 19**

## Power Cord Replacement

**Tools Required:** Phillips Head Screwdriver

**⚠ CAUTION:** If unit was operating prior to servicing allow at least 10 minutes for lights, heating elements and top panel to cool off to avoid accidental burning of skin.

**⚠ WARNING:** Disconnect power before attempting any maintenance to reduce the risk of electric shock or damage to persons.

1. Remove the firebox from the mantel.
2. Remove the eight (8) Philips screws that fasten the top cover to the rest of the firebox. There are: three (3) screws on each side along the top edge; and two (2) screws on the back along the top edge (Figure 12).
3. Flip the top panel over and rest it on the top of the fireplace.

**⚠ CAUTION:** Use caution when flipping top panel over as there are components attached to the top panel which are wired to the internal cavity of the fireplace.

4. Disconnect the two (2) wire connections leading from the existing power cord. One (1) leads to the bottom terminal of the On/Off Switch, the other leads to the Neutral terminal on the Remote Control Receiver mounted to the underside of the Top Panel (Figure 21).
5. Using pliers, squeeze the sides of the plastic wire clamp on the inside of the fireplace and push it, and the power cord through the chassis (Figure 21).
6. Release clamp from power cord and remove cord from fireplace.
7. Feed replacement power cord through opening in the access panel and secure with clamp.
15. The wide blade of the power plug is designed to be neutral and is connected to the cord side with ridges in the rubber of the cord. Connect this side of the Power Cord to the Neutral (N) terminal of the Remote Control Receiver.
16. The other side of the Power Cord will have stamped writing in the rubber sheath and is live. Connect this side of the Power Cord to the bottom terminal of the On/Off Switch.
17. Reassemble firebox
18. Replace firebox back into mantel and plug in.

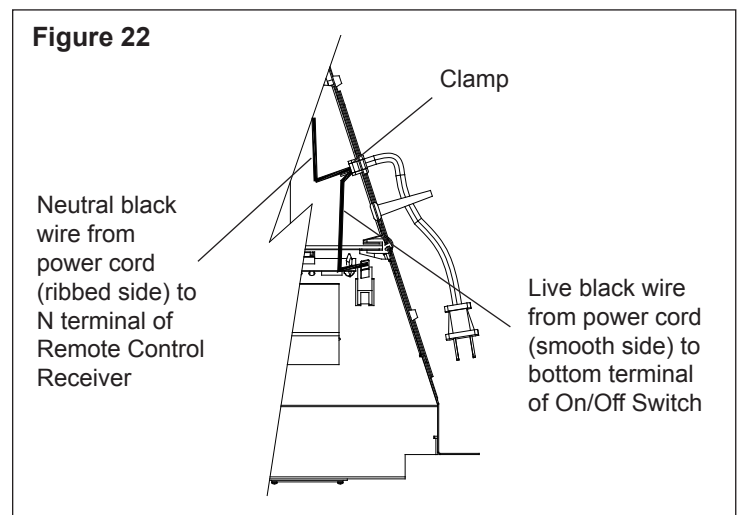
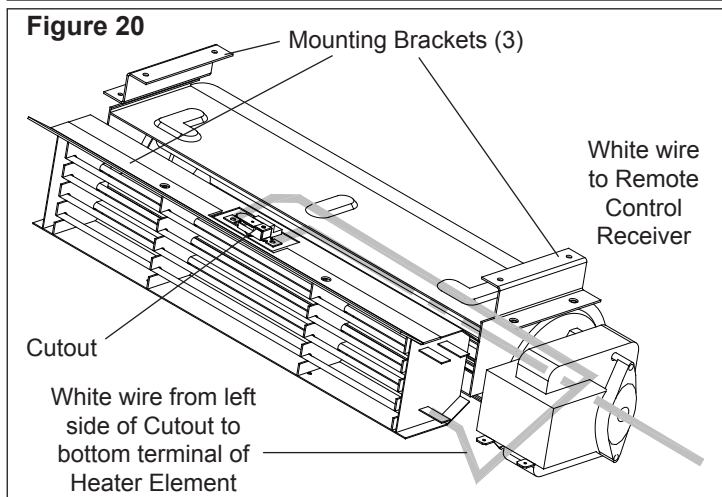
**Figure 22****Figure 20**

top panel (Figure 18).

5. Disconnect all six (6) wire connections at the side of the Heater Assembly, noting all of their original positions.
  6. Turn the top panel over and while supporting the Heater Assembly and panel in one hand, remove the four (4) heater mounting screws (Figure 19).
  7. Carefully separate the Heater Assembly from the top panel, as the Cutout is mounted to the Heater Assembly (Figure 20).
  8. Remove the Philips screw that holds the Cutout to the Heater Assembly - Replace the cutout if required. Follow wiring reference in Figure 20.
- ! NOTE:** Reassemble in reverse order from this point if repair is complete. Continue if replacing Heater Assembly.
9. Remove the three (3) Mounting Brackets as shown in Figure 20. Each bracket will be attached to the Heater Assembly by two (2) Philips screws.
  10. Attach the Cutout to the new Heater Assembly using the same screw removed in step 8.
  11. Reattach the Heater Assembly to the top panel using the four (4) screws from step 6.
  12. Using Figure 20 as a reference, as well as notes made in step 5, reconnect the six (6) wire connections between the Heater Assembly and Remote Control Receiver.
  13. Reattach the Top Panel to the fireplace using the eight (8) screws removed in step 2.
  14. Insert fireplace back into mantel.



Figure 21

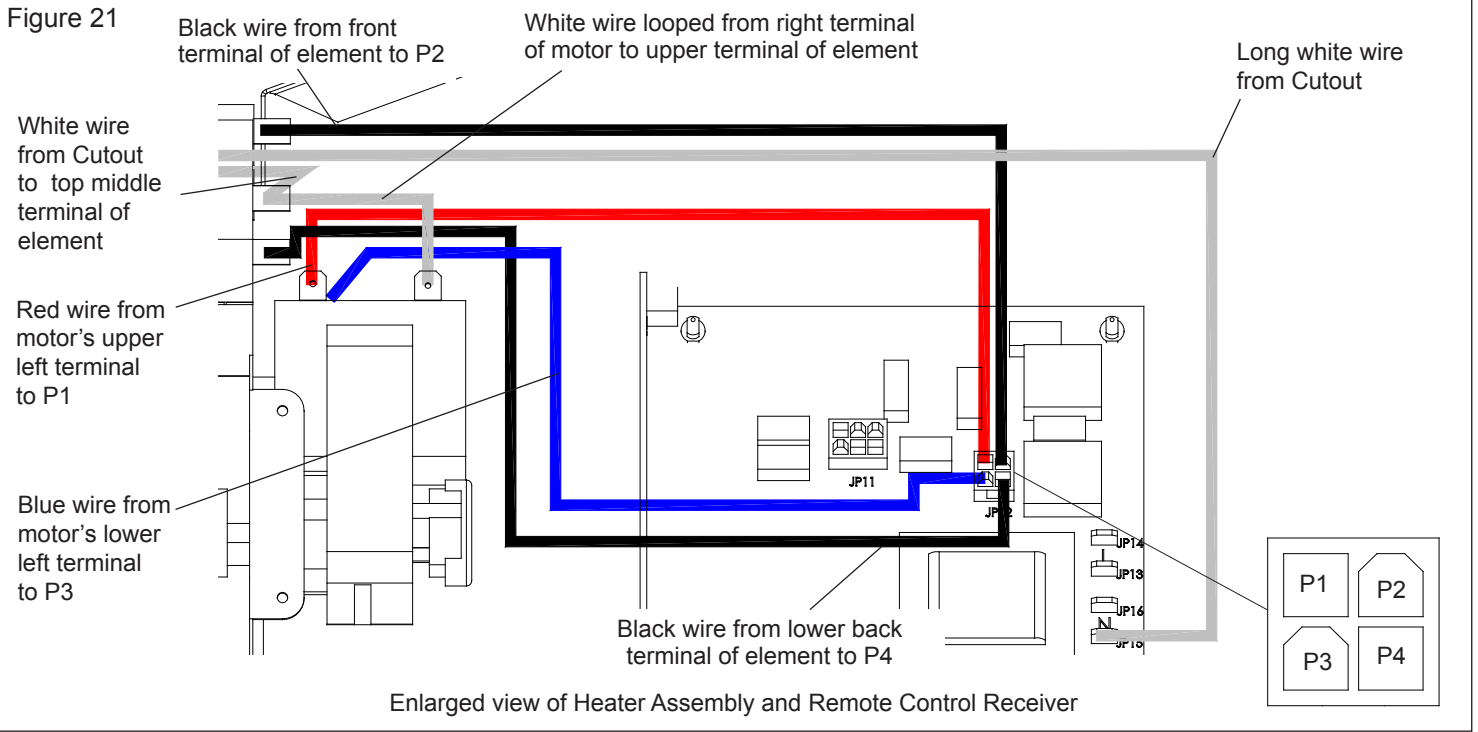

# Troubleshooting Guide

PROBLEM	CAUSE	SOLUTION	PART NUMBER
<b>General</b>			
Circuit breaker trips or fuse blows when unit is turned on	Short in unit wiring.	Trace wiring in unit.	
	Improper circuit current rating	Additional appliances may exceed the current rating of the circuit breaker or fuse. Plug unit into another outlet or install unit on a dedicated 15 amp circuit.	
Unit turns on or off by itself	Improper operation (Full Feature Remote)	Refer to Operation Section - Check Occupancy Sensor Settings	
	Remote Control has a similar frequency to other remotes in the area.	Change the frequency of the Remote Control - See Operation Section.	
	Defective Remote Control Receiver	Replace Remote Control Receiver. Initialize Remote Control and Receiver	See RP list for specific receiver
Lights dim in room while the unit is on	Unit is drawing close to circuit current rating	Move the unit to another outlet or install unit on a dedicated 15 amp circuit	
Power Cord gets warm	Normal Operation	The power cord may get slightly warm to the touch when the heater is on	
	Defective Power Cord	Replace Power Cord if cord gets hot to the touch.	4100040400RP
<b>Appearance</b>			
Fireplace does not turn on Manually	Improper operation	Refer to Operation Section	
	No incoming power from the electrical wall socket	Check fuse/breaker panel	
	Defective On/Off Switch	Replace On/Off Switch	2800070700RP
	Defective Remote Switchboard	Replace Remote Switchboard	3000320300RP
Fireplace does not turn on using the Remote Control	Improper operation	Refer to Operation Section	
	Remote Control not initialized to fireplace	Initialize the Remote Control	
	Loose wiring.	Check wiring connections.	
	Remote Control not working	Install new batteries into the Remote Control. Initialize Remote Control.	
Replace Remote Control or Remote Control Receiver where necessary. Initialize Remote Control Receiver and Remote Control.		See RP list for specific remote and receiver	
Flame Frozen	Defective Flicker Motor	Replace Flicker Motor	3000240200KIT
	Loose wiring	Check wiring connections	
Flame not bright or flame not visible	Burnt out light bulbs	Replace light bulbs	
	Loose wiring	Check wiring connections	
	Defective Lower Light Harness	Replace Lower Light Harness	2500200200RP
Log set dim, not glowing	Loose wiring connection	Check wiring connections	
	Defective Remote Control Receiver	Replace Remote Control Receiver. Initialize Remote Control and Receiver	See RP list for specific receiver
	Defective Log Set	Replace Log Set	0439070100RP
Flame Shudder	Defective Flicker Motor	Replace Flicker Motor	3000240200KIT
Light leaking around the log set	Log set not positioned properly	Check log set for proper fit	

PROBLEM	CAUSE	SOLUTION	PART NUMBER
<b>Heater</b>			
Heater is not turning off (Manually)	Improper operation	Refer to Operation Section	
	Defective Remote Switchboard	Replace Remote Switchboard	3000320300RP
	Defective Remote Control Receiver	Replace Remote Control Receiver. Initialize Remote Control and Remote Control Receiver.	See RP list for specific receiver
Heater is not turning on (Manually)	Improper operation	Refer to Operation Section	
	Heater has been disabled	Refer to Operation Section for instructions to enable heater.	
	Loose wiring	Trace wiring in unit	
	Defective Heater Assembly	Replace Heater Assembly	2200490600RP
	Defective Remote Control Receiver	Replace Remote Control Receiver. Initialize Remote Control and Remote Control Receiver.	See RP list for specific receiver
Heater is turning off after a couple of minutes of operation	Build up of dirt/dust in the Heater Assembly	Ensure that exterior intake louvers and firebox cavity are free of dirt/dust.	
	Defective Heater Assembly	Replace Heater Assembly	2200490600RP
Heater emits an odor	Normal Operation	Normal operation is when the heater emits an odor for a brief period after the heater is initially turned on. The heater is burning off any dust accumulated during manufacturing or operation.	
	Defective Heater Assembly	Replace Heater Assembly	2200490600RP
Heater fan turns on but heater lacks heat	Improper operation	Refer to Operation Section	
	Loose wiring	Trace wiring in unit	
	Defective Heater Assembly	Replace Heater Assembly	2200490600RP
Heating element is glowing red	Normal Operation	Small glowing sections of the element are considered normal.	
	Defective heater assembly	If larger glowing sections are causing the heater to trip the thermal cutout, unplug unit, discontinue use and replace heater assembly.	2200490600RP
<b>Noise</b>			
Excessive noise with the heater on	Dirty Heater Assembly	Ensure that exterior intake louvers and firebox cavity are free of dirt/dust.	
	Defective Heater Assembly	Replace Heater Assembly	2200490600RP
Grinding or excessive noise with the heater off	Flicker rod hitting or rubbing against internal components	Ensure rod is straight and mounted properly in the bracket, spinning freely away from other components. Replace if necessary.	
	Defective Flicker Motor	Replace Flicker Motor	3000240200KIT