



City Series
MODERN FIREPLACES
WITH NO LIMITATIONS



Unlimited Finishes

- ▶ Use any finishing material right to the edge of your fireplace, even wood
- ▶ Innovative design maintains a cool wall (patent pending)

Frameless Fire

- ▶ Seamlessly integrates into any interior
- ▶ Invisible glass safety barrier (patent pending)

New Perspectives

- ▶ Available in single-sided, two-sided and three-sided designs



NEW YORK VIEW



CHICAGO CORNER

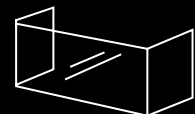

SAN FRANCISCO BAY

Unlimited Finishes

- ▶ TV or art directly above the fireplace
- ▶ Zero clearances to TVs and artwork
- ▶ No internal fans or expensive power-vents required
- ▶ Use any finishing material right to the edge of the fireplace, even wood!
- ▶ Innovative cool wall system (patent pending)





NO LIMITS. NO RESTRICTIONS.

Designed to maintain a cool wall to accommodate custom finishes right to the edge of your fireplace!

ADVANTAGES

- ▶ Place a TV above the fireplace without it getting damaged
- ▶ Hang artwork without fear of warping
- ▶ Use any finish right to the edge of the fire, even wood or wallpaper
- ▶ Paint will not discolor, drywall will not crack
- ▶ No internal fans or expensive power-vents required



Wood



Wallpaper



Fabric

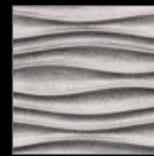

Textured Panel



Metal

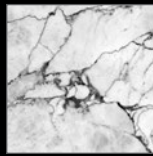

Marble



Tile



Embossed Panel



Glass



Faux Stone

FRAMELESS FIRE

- ▶ An uninterrupted view of the flames
- ▶ Seamlessly integrates into any interior
- ▶ Invisible glass safety barrier (patent pending)
- ▶ No frames, mesh or silicone
- ▶ Integrated liner panel options and black glass accessories



Controllable Warmth

- ▶ Natural heat circulation at ceiling level
- ▶ Silent and reliable, no fans required
- ▶ Remote controlled flame height and accent lights



FLEXIBLE VENTING OPTIONS

Regency's patent pending system releases its warmth at ceiling level. This system reduces excessive radiant heat in front of the fireplace so you can enjoy your fireplace more often.

- ▶ Design your own chase vent solution to suit your home
- ▶ Or use optional front or side chase vent grills
- ▶ Release the warmth into the same room, or an adjacent room



Front



Side

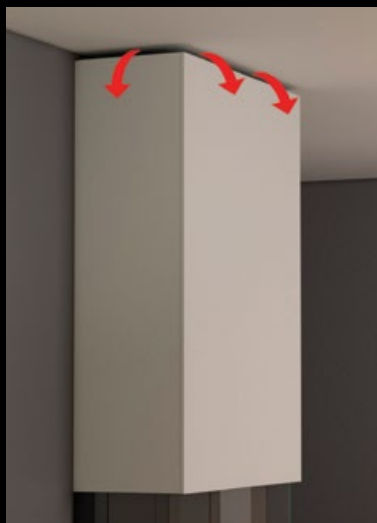

Top



Back

San Francisco Bay

CB40E IN SIZE 40"

Regency's three-sided bay fireplace creates a focal point that shows off your fire from multiple angles.

VIEWING AREA

WIDTH	48.5"
HEIGHT	15"
DEPTH	14-11/16"

BTU'S

MAX. BTU (NG)	28,500
MIN. BTU (NG)	15,500
MAX. BTU (LP)	28,500
MIN. BTU (LP)	15,500

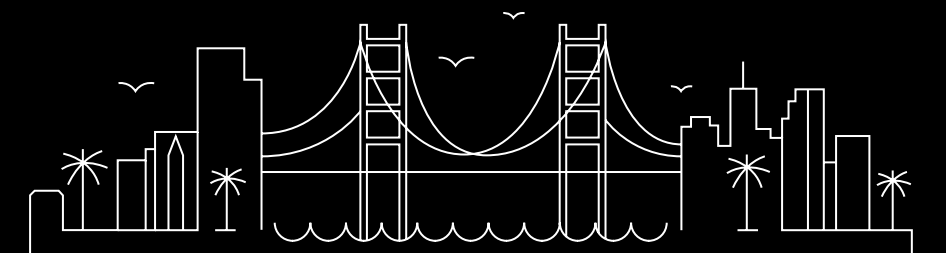



San Francisco Bay 40 shown with crushed coal black glass, volcanic stones & black glass interior panels.

Chicago Corner

CC40LE/CC40RE LEFT OR
RIGHT CORNER IN SIZE 40"

Regency's two-sided corner fireplace allows you to have design flexibility from any side of the room.

VIEWING AREA

WIDTH	44"
HEIGHT	15"
DEPTH	14-11/16"

BTU'S

MAX. BTU (NG)	28,500
MIN. BTU (NG)	15,500
MAX. BTU (LP)	28,500
MIN. BTU (LP)	15,500

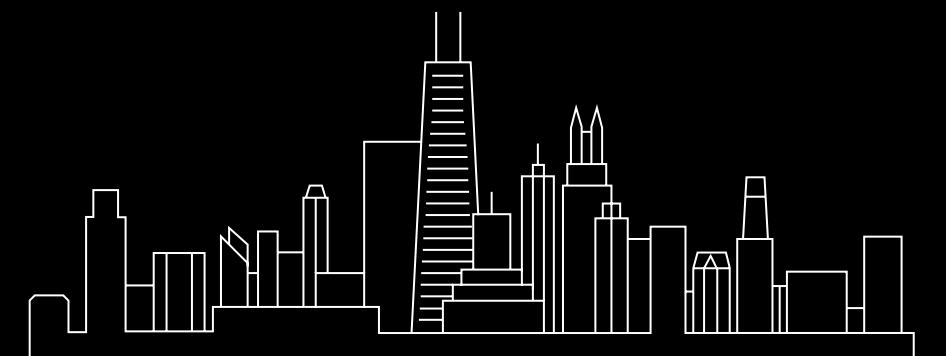



Chicago Left Corner 40 shown with driftwood log set & reflective enamel panels.



FOR MORE DESIGNS & IDEAS
VIEW OUR "DESIGN GALLERY" AT:
regency-fire.com/gallery



*Chicago Right Corner 40 shown with starfire crystals,
iceberg crushed glass & reflective enamel panels.*

New York View

CV40E IN SIZE 40"

This front-facing linear fireplace can be seamlessly integrated into any room because of its frameless design.

VIEWING AREA

WIDTH	40"
HEIGHT	15"

BTU'S

MAX. BTU (NG)	28,500
MIN. BTU (NG)	15,500
MAX. BTU (LP)	28,500
MIN. BTU (LP)	15,500

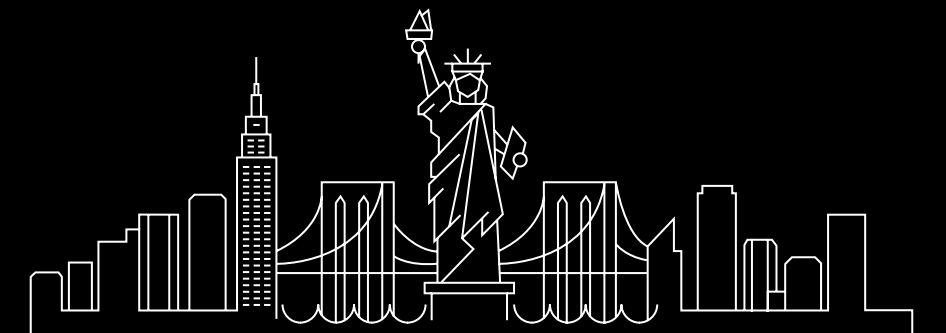



New York View 40 shown with volcanic stones & reflective black glass interior panels.



EXTENDED VIEW PANELS

Flush to the wall and reflective, black glass extended view panels focus the eye, create visual balance and amplify flames for maximum impact. A literal expansion of City Series' frameless firebox, extended view panels integrate seamlessly for a striking, modern, linear look.

- ▶ Create the illusion of a larger fireplace
- ▶ Establish balance on a multi-function fireplace feature wall
- ▶ Black glass reflective finish amplifies the flame experience

1



In this photo, the fireplace is overshadowed by a large television, creating a top heavy fireplace feature wall

2



In this photo, the fireplace achieves visual prominence and balance with the addition of black glass extended view panels

NOTE: Can be used on New York 40 & 72 models to extend the length by 24"

New York View

CV72E IN SIZE 72"

This front-facing linear fireplace can be strikingly integrated into any room.

VIEWING AREA

WIDTH	72"
HEIGHT	15"

BTU'S

MAX. BTU (NG)	46,500
MIN. BTU (NG)	32,000
MAX. BTU (LP)	45,000
MIN. BTU (LP)	36,000





New York View 72 shown with black reflective crystals, crushed coal black glass, volcanic stones & reflective black enamel interior panels.

Create Your Fireplace

► Customize the look of your fireplace by adding fully integrated accessories





TV & Media Wiring Kit

Engineered Finishing Panels (Shown With Sonoma Oak)

Interior Black Reflective Panels

Extended Hearth Framing Kit (Shown With Finishing Panels in Sonoma Oak)

INTEGRATED ACCESSORIES

Page 23: FIREBED OPTIONS

- ▶ Driftwood log set
- ▶ Crystals and crushed glass in various colors
- ▶ Volcanic stones

Page 23: INTERIOR OPTIONS

- ▶ Black matte panels
- ▶ Black enamel reflective panels
- ▶ Premium reflective black glass panels

Page 24-25: OPTIONAL FRAMING KITS

- ▶ Compact chase framing kit
- ▶ Extended chase framing kit
- ▶ Extended hearth framing kit
- ▶ TV & media wiring kit

Page 27: OPTIONAL FINISHING MATERIALS

- ▶ Ready to install finishing panels
- ▶ Reflective black 3 piece glass hearth top
- ▶ Reflective black glass corners to extend the width of your fire

Warm, Realistic Firebed

- ▶ Relaxed, natural flames
- ▶ Richly detailed media options
- ▶ Multiple interior panel options



FIREBED OPTIONS



Driftwood Log Set



Starfire Crystals & Iceberg Crushed Glass



Volcanic Stones



Reflective Black Crystals &
Black Coal Crushed Glass

INTERIOR OPTIONS

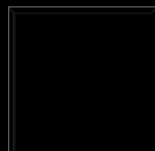

Matte Black
Panels



Premium Reflective
Black Glass Panels



Reflective Black
Enamel Panels



Accent Lights
(Standard)

No Hassle Installation

- ▶ Use wood framing or optional engineered framing kits
- ▶ Integrated control system, no access doors required
- ▶ Telescopic chase framing kits are adjustable from 7 - 10 ft

A COMPACT CHASE FRAMING KIT



B EXTENDED CHASE FRAMING KIT



C EXTENDED HEARTH FRAMING KIT

OPTIONAL FRAMING KITS

	WIDTH	DEPTH	ADJUSTABLE HEIGHT
A COMPACT CHASE	48-1/2"	18-3/4"	46-3/4" - 87-1/4"
B EXTENDED CHASE	60-1/4"	18-3/4"	54" - 94-3/4"
C EXTENDED HEARTH	68-1/2"	25-1/4"	8-1/2" - 11-1/2"
D CORNER CHASE STARTER KIT	49-3/4"	18"	62-7/8" Bottom of unit to top of framing kit

BUILD YOUR OWN CUSTOM FIREPLACE

USE REGENCY STEEL FRAMING

1



2



OR

USE STANDARD WOOD FRAMING

1



2



D CORNER CHASE STARTER KIT



Optional Finishing Panels

- ▶ Create a designer look in a few easy steps
- ▶ One day installation



READY TO INSTALL FINISHING PANELS

- ▶ No designer or external contractors required
- ▶ Multiple configurations
- ▶ A variety of engineered premium panels
- ▶ TV & media wiring kit option

EXTENDED



Shown in Sonoma Oak

COMPACT



Shown in Loft

FINISHES

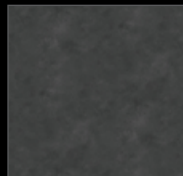

Dark Loft

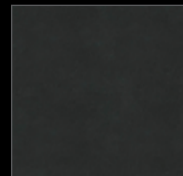

Iron Grey Leather



Loft

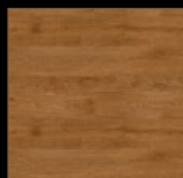

Vintage Oak



Sonoma Oak

SPECS & DRAWINGS

CV40E - TOP

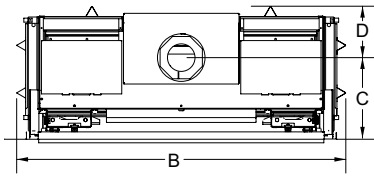

CV40E - FRONT

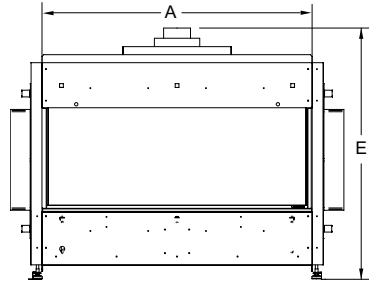

CV40E - SIDE

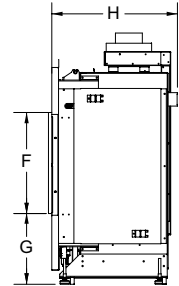

CB40E - TOP

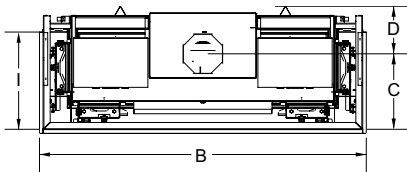

CB40E - FRONT

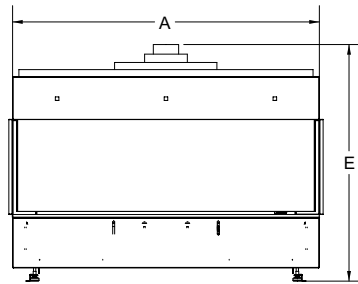

CB40E - SIDE

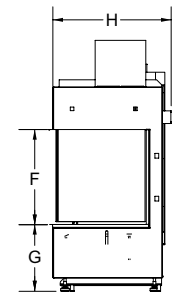

CC40LE/CC40RE - TOP

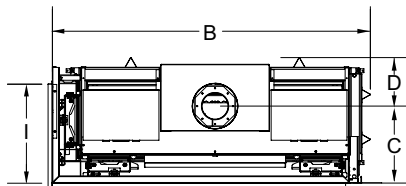

CC40LE/CC40RE - FRONT

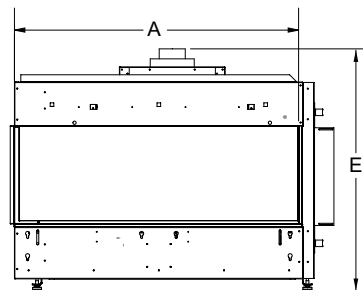

CC40LE/CC40RE - SIDE

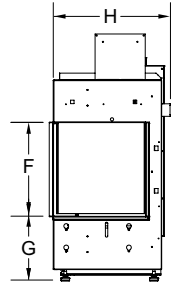

CV72E - TOP

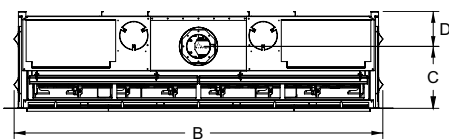

CV72E - FRONT

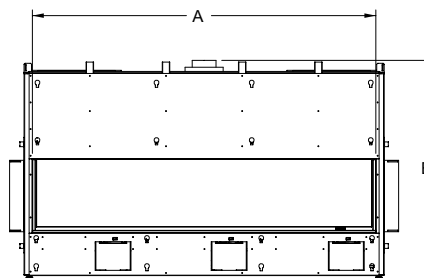

CV72E - SIDE

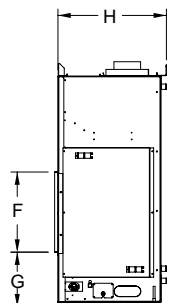

DIMENSIONS

Dimensions for drawings on page 28

DIMENSIONS	CV40E	CC40RE/LE	CB40E	CV72E
A	40"	43-5/8"	48-7/16"	72"
B	46-1/4"	47-3/8"	49-5/8"	77-2/5"
C	11-7/16"	11-7/16"	11-7/16"	13"
D	7-1/4"	7-1/4"	7-1/4"	7-2/5"
E	37-3/8"	37-3/8"	37-3/8"	46"
F	15-1/16"	15-1/16"	15-1/16"	15-1/16"
G	10-1/2"	10-1/2"	10-1/2"	10-1/2"
H	18-11/16"	18-11/16"	18-11/16"	20-3/10"
I	--	14-11/16"	14-11/16"	--
VENTING	4" X 6-5/8"	4" X 6-5/8"	4" X 6-5/8"	5" X 8"

CLEARANCES

CC40RE/LE

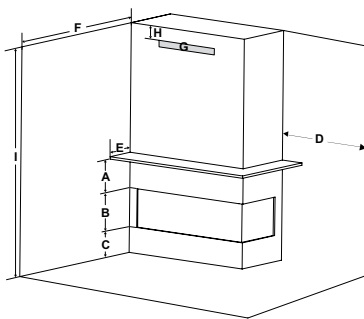

CV40E/CV72E

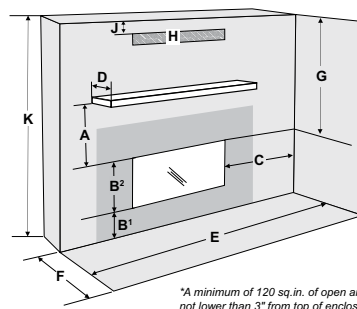

*A minimum of 120 sq. in. of open area, not lower than 3" from top of enclosure, required for all installations

CLEARANCES

CB40E

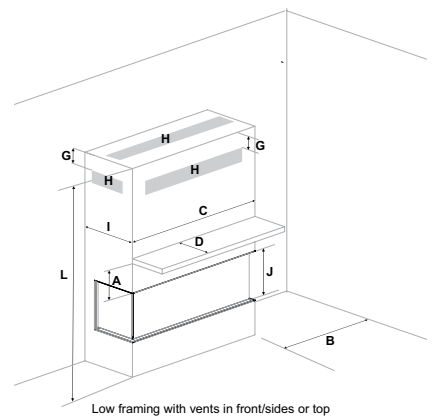
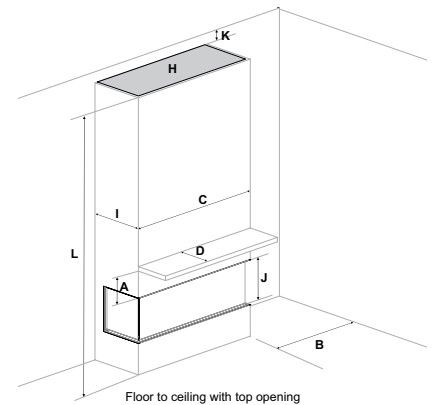

CLEARANCES		CC40RE/LE
A	Mantel Height (min.)	**
B	Opening Height	15-1/16"
C	From Floor	Min. 0"
D	Sidewall (on one side)	Min. 36"
E	Mantel Depth (max.)	**
F	Alcove Depth	Min. 36"
G	Convection Air Outlet	120 sq. in.
H	Convection Air Outlet Opening Offset	0 - 3"
I	Chase Enclosure (min.)	63"
	Hearth	0"

CLEARANCES		CV40E	CV72E
A	Mantel Height (min.)	**	**
B1	From Floor	Min. 0"	*
B2	Opening Height	15-1/16"	15-1/2"
C	Sidewall (on one side)	8-1/2"	8"
D	Mantel Depth (max.)	**	**
E	Alcove Width	84"	88"
F	Alcove Depth	36"	36"
G	Ceiling (in front of fireplace)	37-1/2"	61-3/4"
H	Convection Air Outlet	120 sq. in.	*
J	Convection Air Outlet Opening Offset	0 - 3"	*
K	Chase Enclosure (min.)	63"	87"
	Hearth	0"	**

CLEARANCES		CB40E
A	From Floor	Min. 0"
A	Mantel Height (min.)	**
B	Sidewall (on one side)	8-1/2"
C	Enclosure Width (min.)	48-7/16"
D	Mantel Depth (max.)	**
E	Alcove Width	84"
F	Alcove Depth	36"
G	To Enclosure Ceiling (min./max.)	0 - 3"
H	Convection Air Outlet	120 sq. in.
I	Enclosure Depth (min.)	19"
J	Opening Height	15-1/16"
K	To Ceiling (min.) - All 3 sides	1-1/2"
L	Chase Enclosure (min.)	63"
	Hearth	0"

*See manual for details

**See mantel clearances chart in manual

NOTE: All products can be installed in a raised application. Before installing refer to the relevant product manual for full and up-to-date information.

Manuals can be downloaded from our website www.regency-fire.com

FRAMING DRAWINGS

CV40E/CV72E

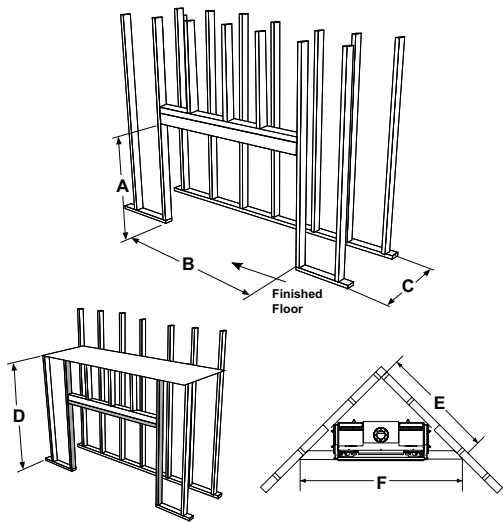

CB40E

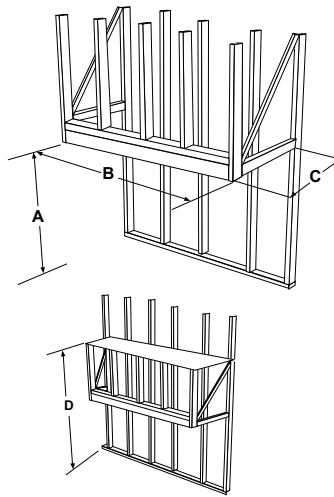

CC40RE/LE

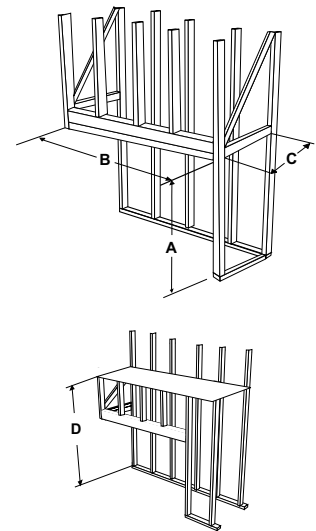

CLEARANCES		CV40E	CC40RE/LE	CB40E	CV72E
A	Framing Height	37-3/8"	37-3/8"	37-3/8"	51"
B	Framing Width	46-3/4"	48-1/4"	48-1/2"	78"
C	Framing Depth	19"	19"	19"	20-5/8"
D	Minimum Height to Combustibles	63"	63"	63"	87"
E	Corner Wall Depth	55"	-	-	82-1/8"
F	Corner Facing Wall Width	77-3/4"	-	-	116-3/16"

Visit www.regency-fire.com for City Series downloads including:

- ▶ Specifications
- ▶ Detailed drawings
- ▶ Manuals
- ▶ Framing & clearances

HEAT DISTRIBUTION

Increase the effectiveness of your fireplace by dispersing warm air from the fireplace to remote locations in the same room or other rooms in your home by using the heat distribution kit.

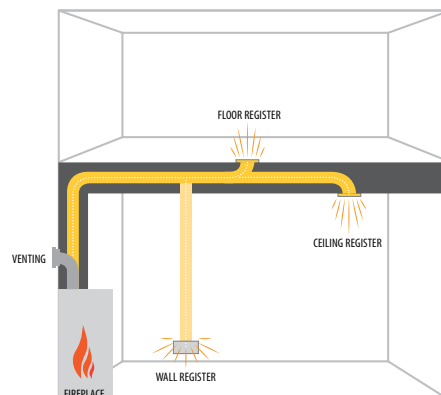

ACCESSORIES

ACCESSORIES - AT A GLANCE			CV40E	CC40RE/LE	CB40E	CV72E
Clean face design			✓	✓	✓	✓
Interior options	Firebed	Crystals in various colors	★	★	★	★
		Firebeads in various colors	★	★	★	★
		Ceramic spa stones	★	★	★	★
		Volcanic stones	★	★	★	★
		Sea Wool	✓	✓	✓	✓
	For firebox floor	Crushed Glass in various colors	★	★	★	★
		Natural river pebbles	★	★	★	★
	Driftwood logs		★	★	★	★
	Inner panels	Matte Black	★	★	★	★
		Black Enamel	★	★	★	★
Black Glass		★	★	★	★	
Glass safety barrier			✓	✓	✓	✓
Extended view side panels			★	•	•	★
Framing kits	Compact Chase		•	•	★	•
	Extended Chase		•	•	★	•
	Extended Hearth		•	•	★	•
	Corner Chase Starter Kit		•	★	•	•
Finishing panels	Compact Chase finishing panels in various colors		•	•	★	•
	Extended Chase finishing panels in various colors		•	•	★	•
	Compact Hearth finishing panels in various colors		•	•	★	•
	Extended Hearth finishing panels in various colors		•	•	★	•
Hearth top - black glass			•	•	★	•
TV wiring kit			★	★	★	★
Chase grills	Front Chase Grill (120 sq.in. opening)		★	★	★	•
	Side Chase Grill 2pk (120 sq.in. opening)		★	★	★	•
Accent lights			✓	✓	✓	✓
Controls	Proflame II GTMF		✓	✓	✓	✓
Venting	Direct Vent		★	★	★	★
	AstroCap® Venting System		★	★	★	★
	Heat Wave™ Power Duct System		★	★	★	★
	Heat Wave adapter		★	★	★	•
Propane conversion kit			★	★	★	★

- Not available
- ✓ Standard
- ★ Optional

COOL WALL SYSTEM

The cool air is drawn into the system around the floating glass safety barrier, then the cooler air is split between the heat exchanger and the inside wall surface.

The air travelling through the heat exchanger is heated by the fireplace and then directed out the back of the fireplace. The combined warmed air is then vented back into the room.





WWW.REGENCY-FIRE.COM

© 2017 FPI Fireplace Products International Ltd. Regency®, AstroCap® and Heat Wave™ are registered or proprietary trademarks of FPI Fireplace Products International Ltd. All rights reserved.
Printed in Canada (08/17)
Part No. 944-427

Your Regency Dealer