

# Installation Manual



# PORTRAIT

Direct Vent Insert  
Gas Fireplace  
natural gas 530INI  
propane gas 530IPI

Installer: Place model/serial number here.

Installer: Leave this manual with the appliance.  
Consumer: Retain this manual for future reference.

**⚠ WARNING:**  
**FIRE OR EXPLOSION HAZARD**  
Failure to follow safety warnings exactly could result in serious injury, death, or property damage.

Do not store or use gasoline or other flammable vapors and liquids in the vicinity of this or any other appliance.

#### WHAT TO DO IF YOU SMELL GAS

- Do not try to light any appliance.

- Do not touch any electrical switch; do not use any phone in your building.
- Leave the building immediately.
- Immediately call your gas supplier from a neighbor's phone. Follow the gas supplier's instructions.
- If you cannot reach your gas supplier, call the fire department.

Installation and service must be performed by a qualified installer, service agency or the gas supplier.

## **⚠ DANGER**



Hot glass will cause burns.

Do not touch glass until cooled.

Never allow children to touch glass.

A barrier designed to reduce the risk of burns from the hot viewing glass is provided with this appliance and must be installed for the protection of children and other at-risk individuals.

**This appliance may be installed in an after-market permanently located, manufactured (mobile) home where not prohibited by local codes. This appliance is only for use with the type of gas indicated on the rating plate. This appliance is not convertible for use with other gases, unless a certified kit is used.**

**INSTALLER:** Leave this manual with the appliance.  
**CONSUMER:** Retain this manual for future reference.

#### Massachusetts:

The piping and final gas connection must be performed by a licensed plumber or gas fitter in the State of Massachusetts.

#### **⚠ WARNING**

This product can expose you to chemicals including Benzene, which is known to the State of California to cause cancer and birth defects or other reproductive harm. For more information go to [www.P65Warnings.ca.gov](http://www.P65Warnings.ca.gov).

Note: Natural gas, in its original state, contains Benzene.

This manual contains instructions to install the **ENGINE ONLY**. A trim kit is **REQUIRED** to complete the installation. A barrier screen is provided with the trim kit. **Refer to the manual supplied with the trim for installation.**

**This appliance is a domestic room-heating appliance. It must not be used for any other purposes such as drying clothes, etc.**

**This appliance is suitable for installation in a bedroom or bed sitting room.**

Ce guide est disponible en français sur demande.



We recommend a US Certified National Fireplace Institute (NFI) specialist install our gas hearth products.



The information contained in this manual is believed to be correct at the time of printing. Miles Industries Ltd. reserves the right to change or modify any information or specifications without notice. Miles Industries Ltd. grants no warranty, implied or stated, for the installation or maintenance of your heater, and assumes no responsibility for any consequential damage(s).

© Copyright Miles Industries Ltd., 2022. All rights reserved.  
Designed and manufactured for Miles Industries Ltd.

# Welcome to Valor®

This appliance has been professionally installed by:

Dealer Name: \_\_\_\_\_

Phone: \_\_\_\_\_

**Please read this manual BEFORE installing and operating this appliance.**

<b>Fireplace Safety .....</b>	<b>4</b>
<b>Specifications .....</b>	<b>6</b>
<b>Kits &amp; Accessories.....</b>	<b>7</b>
<b>Dimensions &amp; Cavity.....</b>	<b>8</b>
<b>Clearances .....</b>	<b>9</b>
<b>Installation Planning.....</b>	<b>10</b>
Overview .....	10
Co-Linear .....	11
Co-Axial.....	12
<b>Venting.....</b>	<b>13</b>
Overview .....	13
Restrictors.....	14
<b>Preparation .....</b>	<b>15</b>
Existing Fireplace Preparation.....	15
Before Installation .....	16
Window and Burner .....	17
<b>Installation .....</b>	<b>18</b>
Venting.....	18
Co-Linear Applications .....	18
Co-Axial Applications.....	19
Gas Supply.....	20
Liners Panels—Traditional Logs & Coals .....	21
Fuel Beds .....	22
Traditional Logs Set 530LSK .....	22
Coal Set 530CSK.....	23
Rock Set and Liners 530RSK.....	24
Driftwood Kit and Liners 530DWK.....	26
Refit & Check Window.....	28
Battery Holder.....	29
Remote Control Pairing.....	30
Burner aeration.....	31
Accessories .....	32
Front and Barrier Screen .....	32
Handset Wall Holder.....	32

<b>Wiring Diagram.....</b>	<b>33</b>
<b>Approved Venting Components.....</b>	<b>34</b>
<b>Appendix A – Lighting Instructions Plate.....</b>	<b>35</b>
<b>Appendix B – Remote Control Operation ....</b>	<b>36</b>
<b>Appendix C – Spare Parts .....</b>	<b>40</b>

# Fireplace Safety

This manual contains very important information about the safe installation and operation of the fireplace. Read and understand all instructions carefully before installing and operating the fireplace. Failure to follow these instructions may result in possible fire hazard and will void the warranty.

Replacement manuals are available by contacting the Valor Customer Service at 1-800-468-2567, or by visiting [valorfireplaces.com](http://valorfireplaces.com).

## **WARNING: Extremely Hot!**

### Heat and flammability

- Some parts of the fireplace are extremely hot, particularly the glass window. Use the barrier screen provided or a gate to reduce the risk of severe burns.
- The glass windows can exceed 500°F at full capacity.
- Always keep the appliance clear and free from combustible materials, gasoline, and other flammable vapors and liquids.
- Be aware of hot wall surfaces! The wall directly above the fireplace can get very hot when the fireplace heats. Although safe, it may reach temperatures in excess of 200°F (93°C) depending on choice of optional accessories. Do not touch!
- Be aware of hot hearth/floor surfaces! Any projections directly around the fireplace can get very hot when the fireplace heats. Although safe, they may reach temperatures in excess of 200°F (93°C) depending on elevation of hearth. Be careful of touching these! Temperature of projection surfaces will be reduced when barrier screens are installed.
- Some materials or items, although safe, may discolor, shrink, warp, crack, peel, and so on because of the heat produced by the fireplace. Avoid placing candles, paintings, photos and other combustible objects sensitive to heat or furniture within 36 inches (0.9 m) around the fireplace.
- Solid wood flooring in front of the fireplace (if allowed) may shrink during the heating season due to heat.
- Any safety screen, guard, or barrier removed for servicing an appliance must be replaced prior to operating the appliance

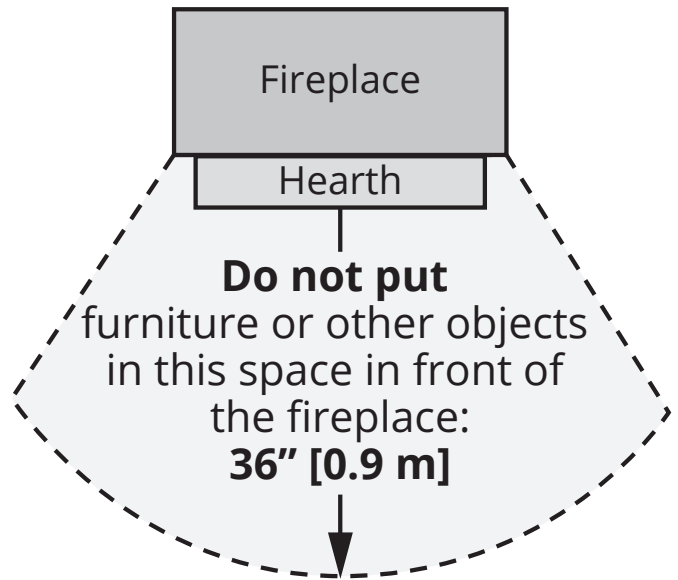

- Due to its high temperatures, the appliance should be located out of traffic areas and away from furniture and draperies.
- Children and adults should be alerted to the hazards of high surface temperature and should stay away to avoid burns or clothing ignition.
- Young children should be carefully supervised when they are in the same room as the appliance. Toddlers, young children, and others may be susceptible to accidental contact burns. A physical barrier is recommended if there are at-risk individuals in the house. To restrict access to a fireplace or stove, install an adjustable safety gate to keep toddlers, young children, and other at-risk individuals out of the room and away from hot surfaces.
- A barrier designed to reduce the risk of burns from the hot viewing glass is provided with this appliance and shall be installed for the protection of children and other at-risk individuals
- Clothing or flammable material should not be placed on or near the appliance.

# Fireplace Safety

## Glass window



### **WARNING**

**Do not operate this appliance with the glass front removed, cracked, or broken. Replacement of the glass front should be performed by a licensed or qualified service person. Do not strike or slam the glass front.**

- The glass front assembly must be in place and sealed before the unit can be placed into safe operation.
- The glass front assembly must only be replaced as a complete unit, as supplied by the fireplace manufacturer. No substitute material may be used.
- Do not use abrasive cleaners on the glass front assembly. Do not attempt to clean the glass when it is hot.

## Venting

- This unit must be used with a vent system as described in this manual. No other vent system or components may be used.
- Never obstruct the flow of combustion and ventilation air. Keep the front of the appliance clear of all obstacles and materials for servicing and proper operation.
- This gas fireplace and vent assembly must be vented directly to the outside and must never be attached to a chimney serving a separate solid fuel burning appliance. Each gas appliance must use a separate vent system. Common vent systems are prohibited.

## Intended use

- This appliance is designed and approved as a supplemental heater and provides the potential for most energy conservation when used while attended. The use of an alternate primary heat source is advisable.
- This unit is not for use with solid fuel.
- Do not use this heater as a temporary source of heat during construction.

## Installation and Servicing

- Installation and repair should be done by a qualified service person. The appliance should be inspected before use and at least annually by a professional service person. More frequent cleaning might be required due to excessive lint from carpeting, bedding material, et cetera. It is imperative that control compartments, burners, and circulating air passageways of the appliance be kept clean.

# Specifications

## Approval & Codes

This appliance is certified to ANSI Z21.88/CSA 2.33 American National Standard / CSA Standard for Vented Gas Fireplace Heaters for use in Canada and USA, and to CGA 2.17-91 High Altitude Standard in Canada. This appliance is for direct vent installations.

This appliance complies with CSA P.4.1-15 Testing method for measuring annual fireplace efficiencies.

The installation must conform to local codes or, in the absence of local codes, with the National Fuel Gas Code, ANSI Z223.1/NFPA 54 or the Natural Gas and Propane Installation Code CAN/CGA-B149.1. Only qualified licensed or trained personnel should install this appliance.

This appliance must be electrically grounded in accordance with local codes, or, in the absence of local codes, with the National Electrical Code, ANSI/NFPA 70 or the Canadian Electrical Code, CSA C22.1.

## Ratings

Model	530INI	530IPI
Gas	Natural	Propane
Altitude (Ft.)*	0-4,500 feet*	
Input Maximum (Btu/h)	20,500	19,000
Input Minimum (Btu/h)	6,500	12,500
Manifold Pressure (in w.c.)	3.5"-3.9"	10.3"-10.7"
Minimum Supply Pressure (in w.c.)	5"	11"
Maximum Supply Pressure (in w.c.)	10.5"	14"
Main Burner Injector Marking	580	200
Pilot Injector Marking	35	27
Min. Rate Bypass Screw	125	125

\* Tested to CGA - 2.17-91 Gas fired appliances for use at high altitudes. In USA, installations may require deration over 2000'— Check local codes.

## \*High Altitude Installations

Input ratings are shown in BTU per hour and are certified without deration for elevations up to 4,500 feet (1,370 m) above sea level.

For elevations above 4,500 feet (1,370 m) in USA, installations must be in accordance with the current ANSI Z223.1 and/or local codes having jurisdiction. Heating value of gas in some areas is reduced to compensate for elevation—consult your local gas utility to confirm.

For installations at elevations above 4,500 feet (1,370 m) in Canada, please consult provincial and/or local authorities having jurisdiction.

## Supply Gas

Heater engine 530INI uses natural gas.  
Heater engine 530IPI uses propane gas.

The supply pressure must be between the limits shown in the *Ratings* section.

The supply connection is 3/8" NPT female and located on the left side of the control valve. The opening for the gas supply line is at the rear left corner of the appliance.

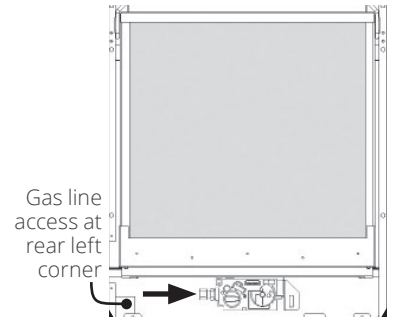

## Gas Conversion Kits

The 530INI/IPI is supplied as natural gas or propane gas and is field convertible between fuels. See instructions packaged with the conversion kits for further information.

## Electrical

The 530 does not require an electrical power source unless fitted with an optional circulating fan. However, if the appliance is fitted with a fan, a grounded power source is required.

## Floor/Hearth

This appliance is approved for installation into existing solid-fuel burning fireplaces only. Combustible material such as plywood and so on may be used for leveling and shimming beneath the unit. This appliance does not require a hearth other than to support the weight of certain fronts.

## Front Trims

Various fronts are available for the 530 insert engine. This engine must be installed as an insert application. The front trim style affects the depth of insert cavity and position of the engine. A front trim kit is required for all applications and should be on site when the engine is installed. 536/541/563 fronts require a closure plate (582/583CPB) to ensure proper position of the casting front.

## Outdoor Conversion Kit

The 530 models are supplied standard for indoor applications and may be adapted for installation in specific "outdoor" applications protected from weather as defined in the GV60CKO outdoor conversion kit manual.

# Kits & Accessories

## Required Kits

Fuel Beds & Liner Panels (choose one)		
530LSK	Traditional Logs & Reversible Liners Set	
530RSK	Rocks & Reversible Liners Set	
530CSK	Coals & Reversible Liners Set	
530DWK	Driftwood & Reversible Liners Set	
Fronts (choose one)		Barrier Screen
536CXBI	President Insert Front (closure plate 582 or 583 required)	4006382
539/549/550	Windsor and Classic Arches (as insert only)	4003290
541BPC	Bolero Front (as insert only) (closure plate 582 or 583 required)	4003289
545CFV	Clearview Insert Front (closure plate 582 optional)	4005146
546LF	Ledgeview Insert Fronts	4005099
563CSB	Senator Front (as insert only) (closure plate 582 or 583 required)	4003291



### WARNING

**Optional electrical accessories ARE NOT ALLOWED when adapting appliance for outdoor use.**

## Optional Accessories

Gas Conversion Kits	
530NGK	Conversion to natural gas
530PGK	Conversion to propane gas
Other Accessories	
GV60CKO	Outdoor Fireplace Conversion Kit
582CPB	Closure Plate, black, 26" w x 31" h (use with 536CXBI, 541BPC, 563SB or 545CFV)
583CPB	Closure Plate, black, 30" w x 33" h (use with 536CXBI, 541BPC or 563CSB)
567FGP	Top Grille (DO NOT USE with coals)
580RGL	Reflective Glass Liners (installs on top of liners supplied with fuel bed)
530CVA2	Co-Axial Appliance Adapter—converts from 2 x 3" co-linear to 5 x 3" co-axial flex using 590FVK2 Flex Vent Kit and Terminal Adapter/Flashing
555CFK	Circulating Fan Kit
1265WSK	Wall Switch Kit
RBWSK	Remote Battery & Wall Switch Kit
GV60PAK	AC Adapter
Hearth Gate	Hearth gates such as Cardinal's VersaGates are available at retail stores carrying safety products for children.

Information accurate at the time of printing and subject to change without notice.

# Dimensions & Cavity

## Dimensions

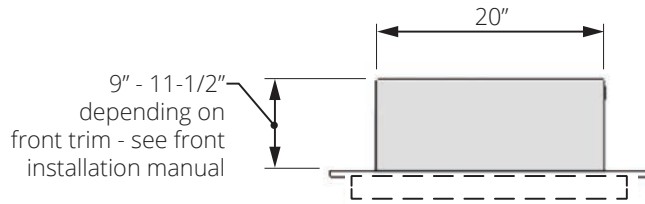

**Attention**  
See below for minimum cavity dimensions!

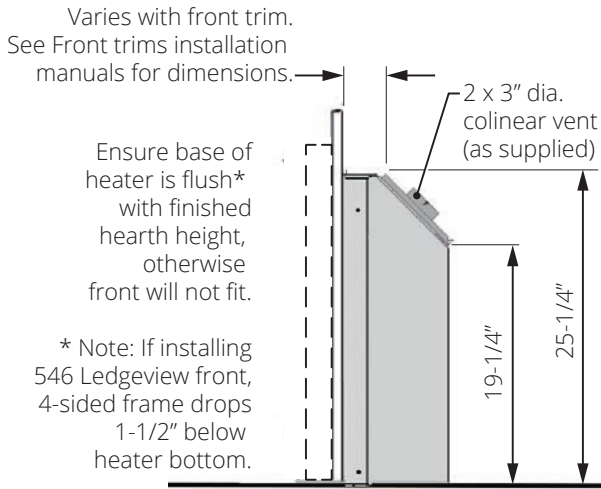

530 insert engine with standard co-linear vent (as supplied)

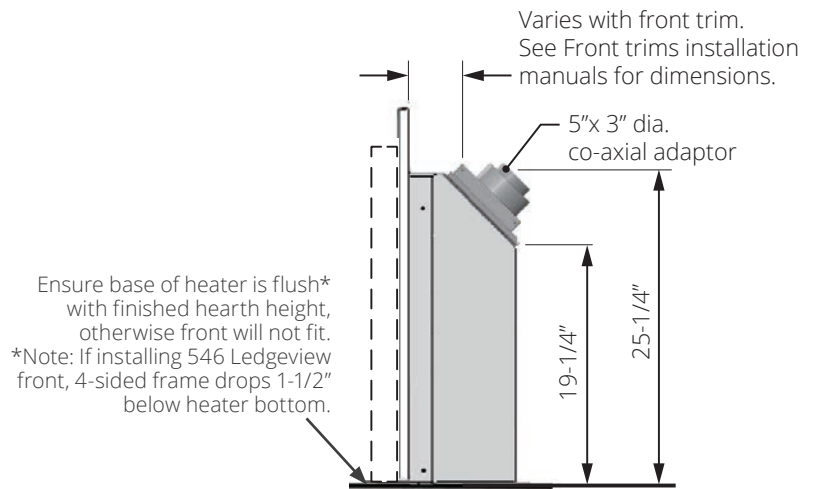

530 insert engine with optional 530CVA2 co-axial appliance adapter

## Cavity

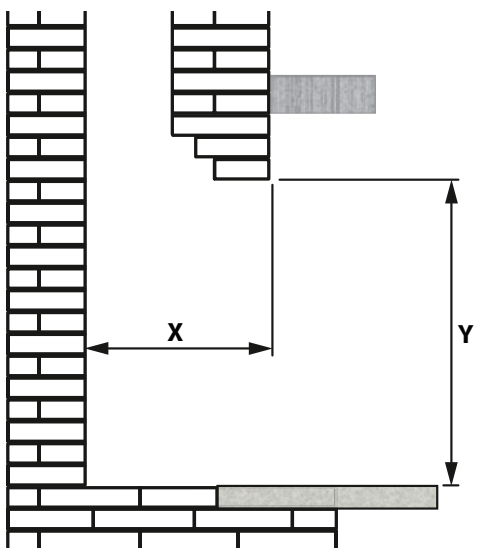

Check that masonry step does not interfere with install dimensions or vent pipe.

If mantel is combustible, see the following section for allowable clearances.

Minimum Cavity Dimensions	
Depth (X)	9-11-1/2" [229-292 mm]—varies with front trim options
Height (Y)	25-1/2" [648 mm]—Note: using 546 Ledgeview front requires additional 1-1/2" [38 mm]
Width (not shown)	20-1/2" [521 mm]



# Clearances

## Combustible Mantel—Left Side View

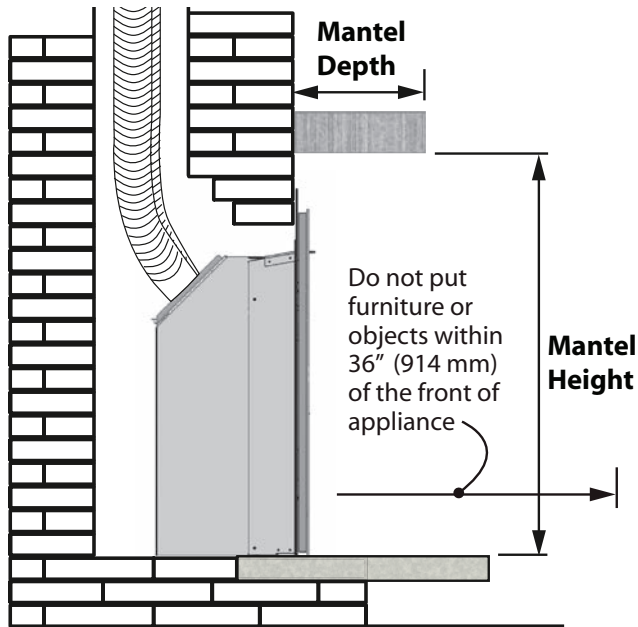

## Combustible Mantel Clearances

See Front trim installation manual.

## Finishing Materials

**Combustible materials:** Materials made of or surfaced with wood, compressed paper, plant fibers, plastics, or other material that can ignite and burn, whether flame proofed or not, or plastered or unplastered.

**Non-combustible materials:** Material which will not ignite and burn. Such materials are those consisting entirely of steel, iron, brick, tile, concrete, slate, glass or plasters, or any combination thereof.

Materials that are reported as passing ASTM E 136, Standard Test Method for Behavior of Materials in a Vertical Tube Furnace at 750 °C

### **WARNING**

**HOT GLASS!** The use of a screen in front of the glass is highly recommended particularly in households with children.

## Sidewall Clearances

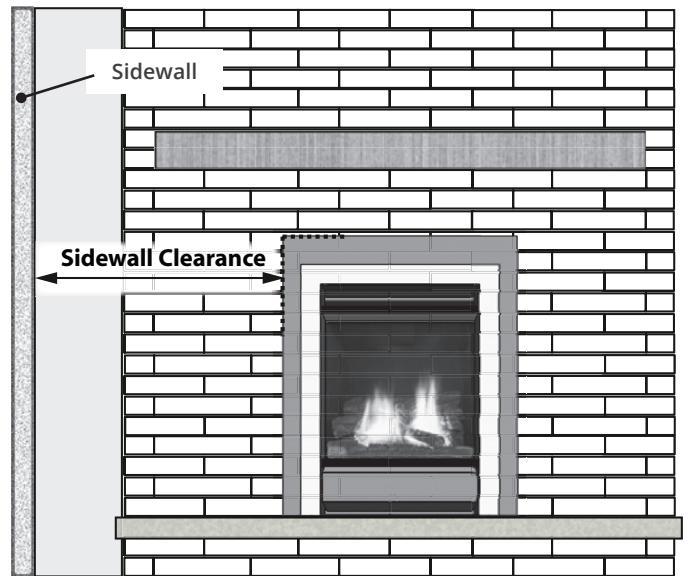

See Front trim installation manual for Sidewall Clearances.

### **WARNING**

**Some materials or items, although safe, may discolor, shrink, warp, crack, peel, and so on because of the heat produced by the fireplace. Avoid placing candles, paintings, photos, and other items sensitive to heat around the fireplace.**

### **WARNING**

**HOT HEARTH / FLOOR!** The hearth or floor in front of the fireplace may become very hot when the fireplace heats. Do not use the hearth as a seat or shelf. Solid wood flooring in front of the fireplace (if allowed) may shrink during the heating season due to heat.

# Installation Planning

## Overview

This appliance may **ONLY** be installed in an existing unaltered, functioning solid-fuel burning fireplace with a working flue and constructed of non-combustible material.

This appliance may be installed in outdoor, weather protected environments as defined in the GV60CKO Outdoor Conversion Kit instruction manual.

**DO NOT** install into combustible construction. This appliance is **NOT APPROVED** for installation with a zero clearance kit.

### **WARNING**

Some materials or items, although safe, may discolor, shrink, warp, crack, peel, and so on because of the heat produced by the fireplace. Avoid placing candles, paintings, photos, and other items sensitive to heat around the fireplace.

### **WARNING**

**HOT HEARTH / FLOOR!** The hearth or floor in front of the fireplace may become very hot when the fireplace heats. Do not use the hearth as a seat or shelf. Solid wood flooring in front of the fireplace (if allowed) may shrink during the heating season due to heat.

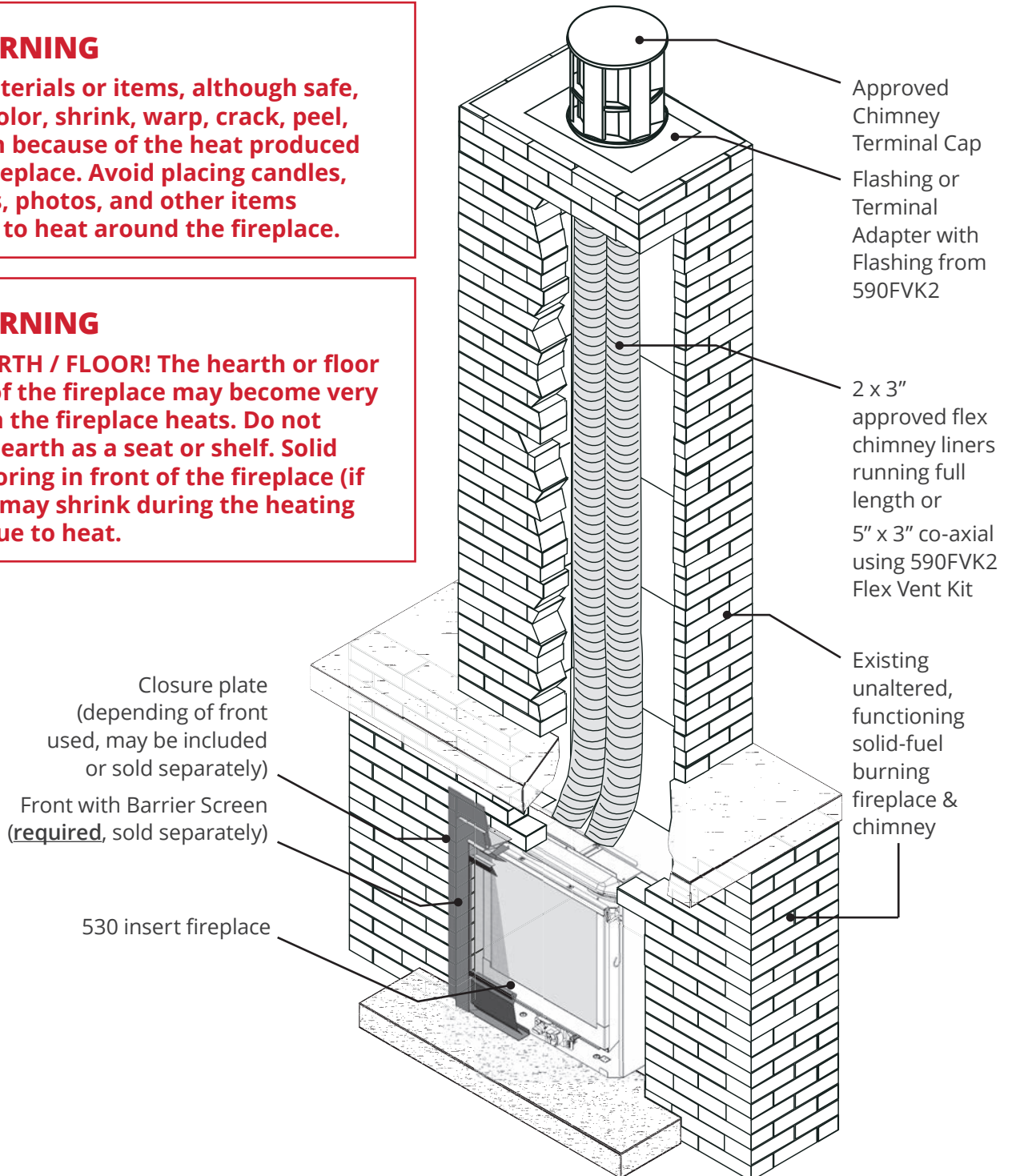

# Installation Planning

## Overview

### Co-Linear—as supplied

#### Venting options

Rear view

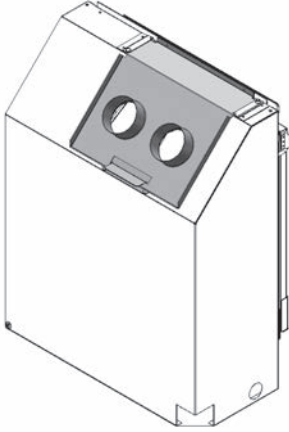

Co-linear appliance, as supplied  
(2 x 3" diameter liners)

### NOTE

536/541/563 fronts require a closure plate (582/583CPB) to ensure proper positioning of casting. Other fronts are supplied with a backing plate included.

### 530INI/IPI as supplied

Co-linear installation into existing F/P

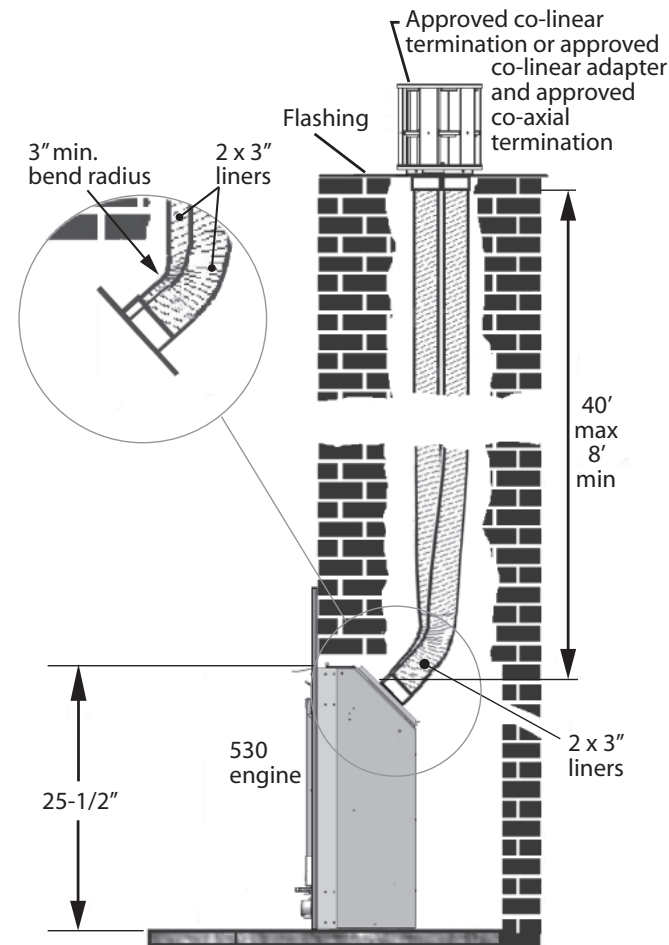

### 530INI/IPI with 720SWK—Sidewall Kit

Sidewall co-linear installation into existing F/P using 720SWK—for units with logs, rocks or driftwood only (see installation instructions supplied with 720SWK)

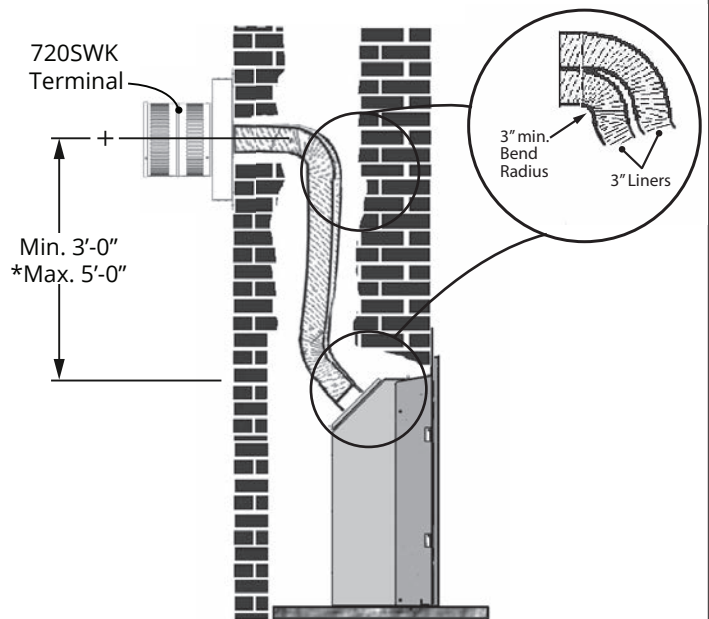

\*Beyond 5'-0", the sidewall terminal may be used but will require restrictors. See 530 section further in this manual.

\* May be extended beyond 5'-0". Refer to the 720SWK installation instructions

# Installation Planning

## Overview

### Co-Axial Conversion

#### Venting options

Rear view

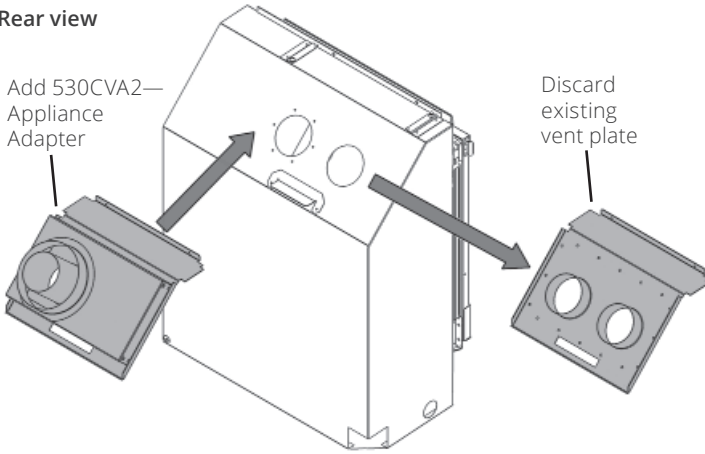

Add optional 530CVA2 for co-axial venting (5" x 3" diameter liners)

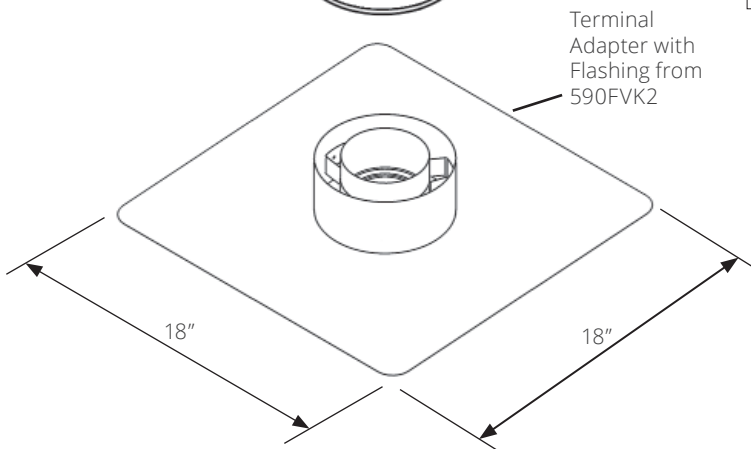
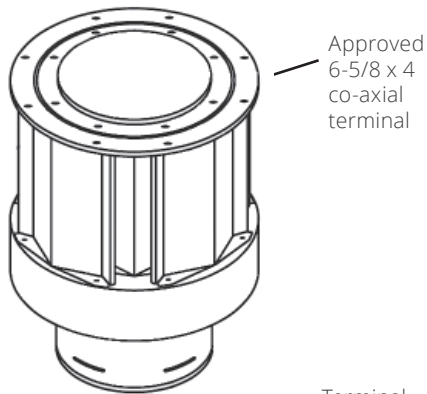

### 530INI/IPI with 530CVA2—Co-axial Appliance Adapter

Co-linear installation into existing F/P

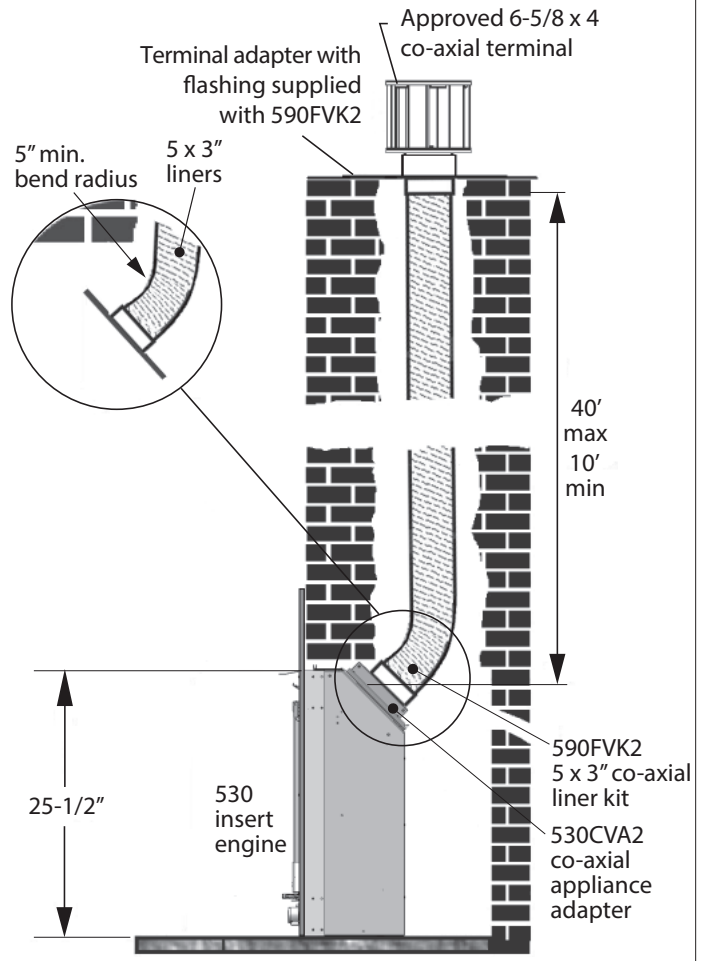

# Venting

## Overview

### Typical Vent Installation

See the *Approved Venting Components* list on page 34 of this manual.

### Vent Location

The vent terminal must be located through the roof. This direct vent appliance is designed to operate when an undisturbed airflow hits the outside vent terminal from any direction.

Check local codes for allowable vertical vent termination.

### Venting Table

Maximum vertical height	40 ft (measured to bottom of termination)
Minimum vertical height	10 ft (measured to bottom of termination)
Maximum horizontal run	4 ft (measured center to center of pipe)
Maximum offset angle	45° (sweeping bend to allow for obstructions)

### Venting Notes

Where possible, avoid splicing flex pipes. If splices are required, use a approved connector and seal joints with *RTV high temp sealant*.

Four feet horizontal is permissible to allow for routing around masonry projections. Do not bend flex pipe over a 45 degrees radius.

1. Co-linear venting may be converted to solid 4" x 6-5/8" co-axial venting at the top of the existing solid-fuel burning chimney as necessary where the existing chimney has deteriorated and been removed. The conversion must be done using approved components (see page 34) and proper vent clearances to combustibles must be maintained.
2. Flex liners may only be installed into solid-fuel burning fireplaces and chimney systems (no combustible construction).
3. The appliance must not be connected to a chimney flue serving a separate solid-fuel burning appliance.

### Note

This appliance may also be vented using the following optional methods (see installation instructions packaged with optional kits):

- 720SWK—Co-linear sidewall kit

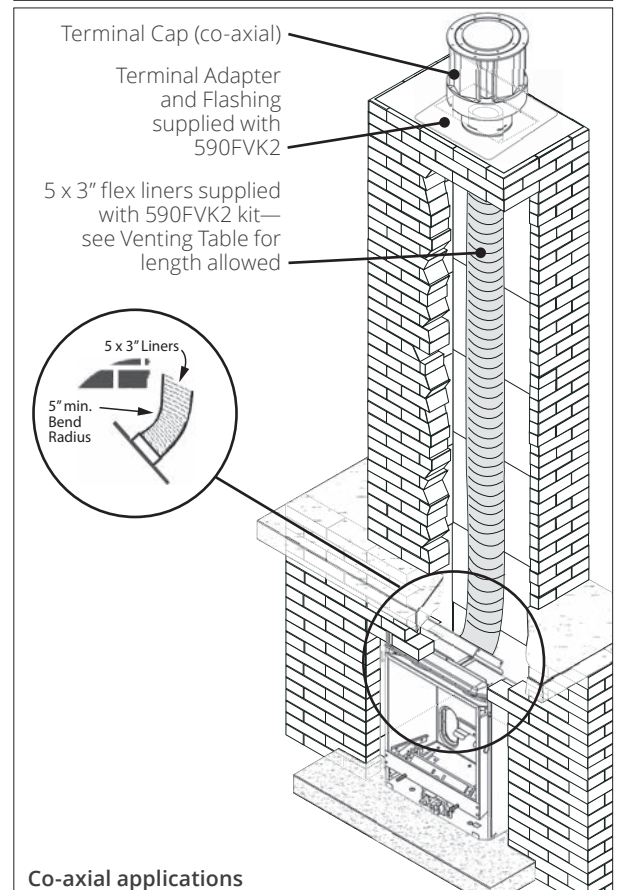
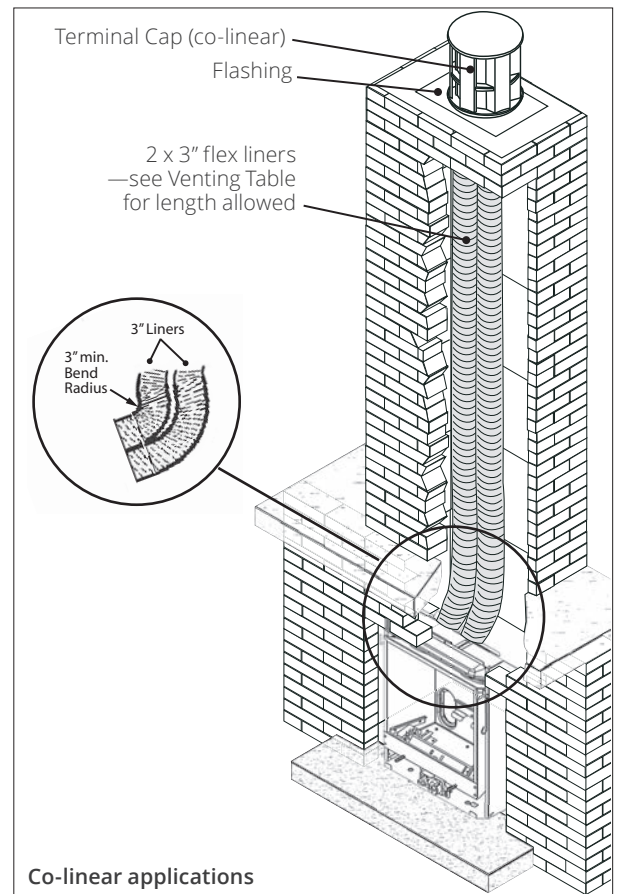



### Attaching Air Restrictors

#### Appliances with more than 10'-0" Vertical Vent Rise Only

No restrictors are required for appliances which that have less than 10'-0" vertical run. If installing an appliance which has less than 10'-0" vertical vent pipe rise, ignore this stage.

Two restrictor sets, like the one shown right, are supplied with each 530 engine unit. The restrictors cover part of the **inlet air openings** in the firebox rear wall on each side of the brick support. **Do NOT install the restrictors in the roof of the firebox!**

Each set is assembled with an adjustable piece which can be moved to different positions depending of the vent configuration. See the table below to find out which position is optimal for each type of installation.

- To fit the restrictors, loosen the two center screws of the left and right inlet ports. Place the restrictor assembly under the screw heads and tighten the center screws.
- To set the adjustable restrictor piece, loosen the two screws, position the adjustable piece according to the diagram below and tighten the screws.

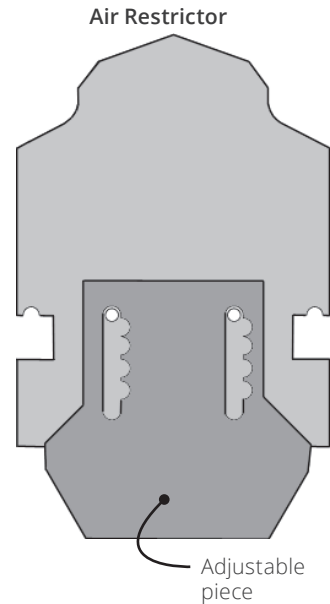

Vertical vent pipe run	Restrictor setting	
	Logs/Rocks	Coals
10-40 ft (3.05-12.2 m)		

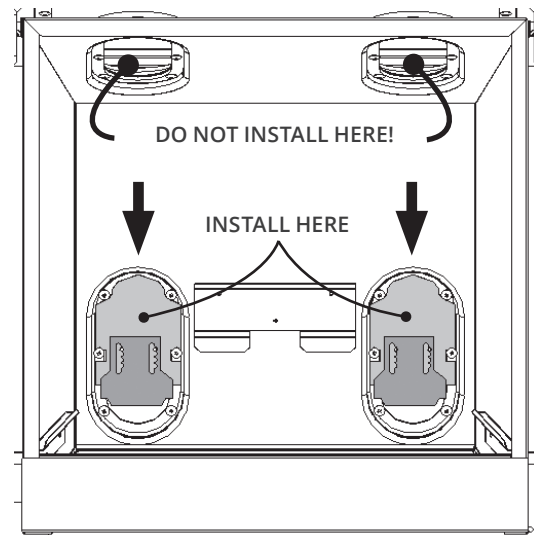

Install restrictors in the **inlet air openings in the firebox rear wall** behind the rear log support.

# Preparation

## Existing Fireplace Preparation

A few points must be considered before inserting the 530 into an existing fireplace cavity. Generally, no modifications are allowed to the existing fireplace that will compromise the integrity of the existing fireplace.

Components that are bolted or screwed on such as dampers or baffles may be removed to accommodate the installation of the 530 engine. Cutting away any sheet metal parts of the existing fireplace to accommodate the installation of the 530 is prohibited.

Check with local authorities if in doubt.

## Clean Fireplace and Chimney

Have the chimney swept and the fireplace cavity including ash dumps and clean-outs cleaned before installing the 530 heater and vent liners. Any creosote or soot residue remaining in the fireplace cavity chimney or clean-out may cause odors or stains once the 530 insert is installed. Consult with chimney sweep for information on how best to clean.

## Existing Dampers

Factory-built, zero-clearance fireplaces will require the damper to be removed in order to install the vent liners. These dampers are usually bolted into place. Dampers in masonry fireplaces must be fixed open and may remain in place.

## Ash Retaining Curbs

Some fireplaces (particularly factory-built) have a raised curb at the front edge to retain ashes. Check the dimensions carefully to ensure the 530 engine will fit behind any raised curb (some curbs may be removed separately from the refractory base).

# Existing Fireplace Preparation

## Gas Line Routing

Plan the routing of the gas line before proceeding. Utilize the existing hole for the gas line of the factory-built fireplace.

If the fireplace has no access hole, carefully drill an access hole of 1.5 inch (38 mm) or less through the lower sides or bottom of the firebox. The access hole must be plugged with non-combustible insulation after the gas supply line has been installed.

See Dimensions section for detailed location of gas inlet. Also, take into consideration whether or not a fan or shut-off valve will interfere when planning routing of the gas line.

## Existing Glass Doors and Wire Screens

Existing glass doors must be permanently removed prior to installing the 530 insert.

## Combustible Mantels

Combustible mantel clearances must conform to those required for the original solid-fuel fireplace into which the 530 is being installed.

## Attach Warning Conversion Plate to Existing Fireplace

(plate supplied loose with 530 heater)

Attach the "This fireplace has been converted..." label to the existing fireplace using screws or other mechanical means and store any removed parts in back of the existing fireplace for future use.

# Preparation

## Before Installation



### Caution

Only qualified, licensed, or trained personnel should install this appliance.

### Installer - READ THIS FIRST!

1. YOU NEED TO KNOW FROM THE HOMEOWNER:
  - What front will be installed;
  - What is the required cavity size/hearth finish;
  - What is the vent configuration;
  - Is there any optional accessories to be installed
2. Unpack the appliance, removing all items packed inside and around it. Recycle the packaging.
3. Check that you have everything, using the Pack Content sheet. Also, check that you have:
  - Front trim
  - Fuel bed and liner panels (packed separately)
  - Gas conversion kit (if necessary)
  - Venting accessories
  - Optional accessories (if ordered)
  - Electrical accessories (if used)
4. Carefully read the Installer's Checklist included with the fireplace for the installation sequence.



### WARNING

**Optional electrical accessories ARE NOT ALLOWED when adapting appliance for outdoor use.**



# Preparation

## Window and Burner

### Remove Window

1. Release the top of the window by pulling forward the two levers at the top corners.
2. Unscrew the two spring-loaded bolts securing the bottom of the window.
3. Carefully lift the window. Keep the window and bolts in a safe place.

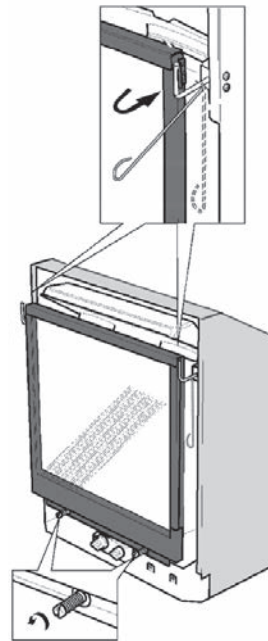

### Remove Burner Module

It may be desirable to remove the burner module to gain access for gas fitting, to install a fan kit, or to fasten the unit to the floor of the fireplace cavity.

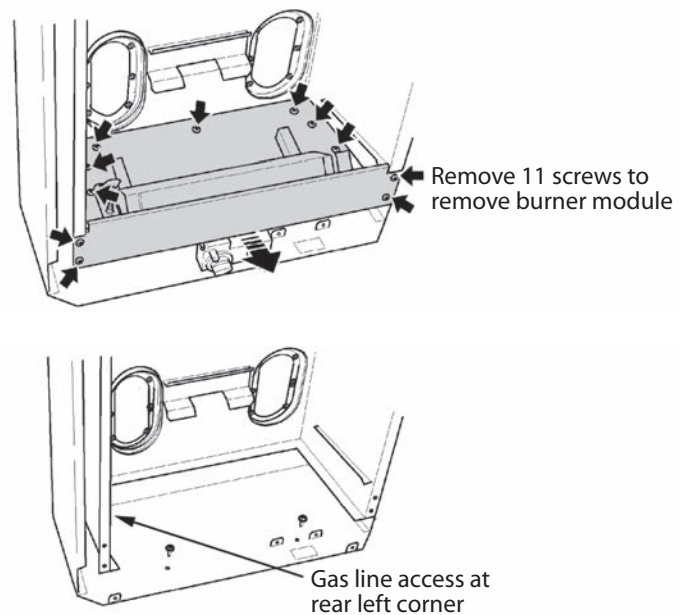

# Installation

## Venting

### Co-Linear Applications (2 - 3" liners)—Connect Venting

**IMPORTANT:** This appliance's venting system is room sealed and therefore, does not require room air to be used in the combustion process.

1. Rough-in two 3" diameter vent liners into the existing chimney system from the roof. Be careful not to tear or damage the liners in the process. It may be easier to install both liners at the same time rather than one at a time. Leave plenty of liner at the bottom to facilitate the connection of the liners to the vent slider. **It is best to leave the top termination until later. Designate and mark the top and bottom of one liner as "EXHAUST" to avoid confusion later.**
2. Release the two screws retaining the vent slider to the front of the firebox. Remove the slider from the firebox by sliding it towards the back of the firebox.
3. Fit the two liners ensuring that the *exhaust* liner is connected to the identified "EXHAUST" vent collar. Secure liners to collars with hose clamps (included) and 2 tapping screws per liner.
4. Slide the firebox onto the vent slider in the cavity taking care not to damage the liners. **Make sure that the rear edge of the slider is hooked over the cleat on the firebox.** Secure the vent slider to the front of the firebox with two screws removed earlier.
5. From the roof, pull the liners and fit the flashing.
6. Fit the terminal cap ensuring that the exhaust liner is connected to the exhaust vent collar. Secure with 8 screws provided.
7. Seal the terminal and flashing from water penetration as required.

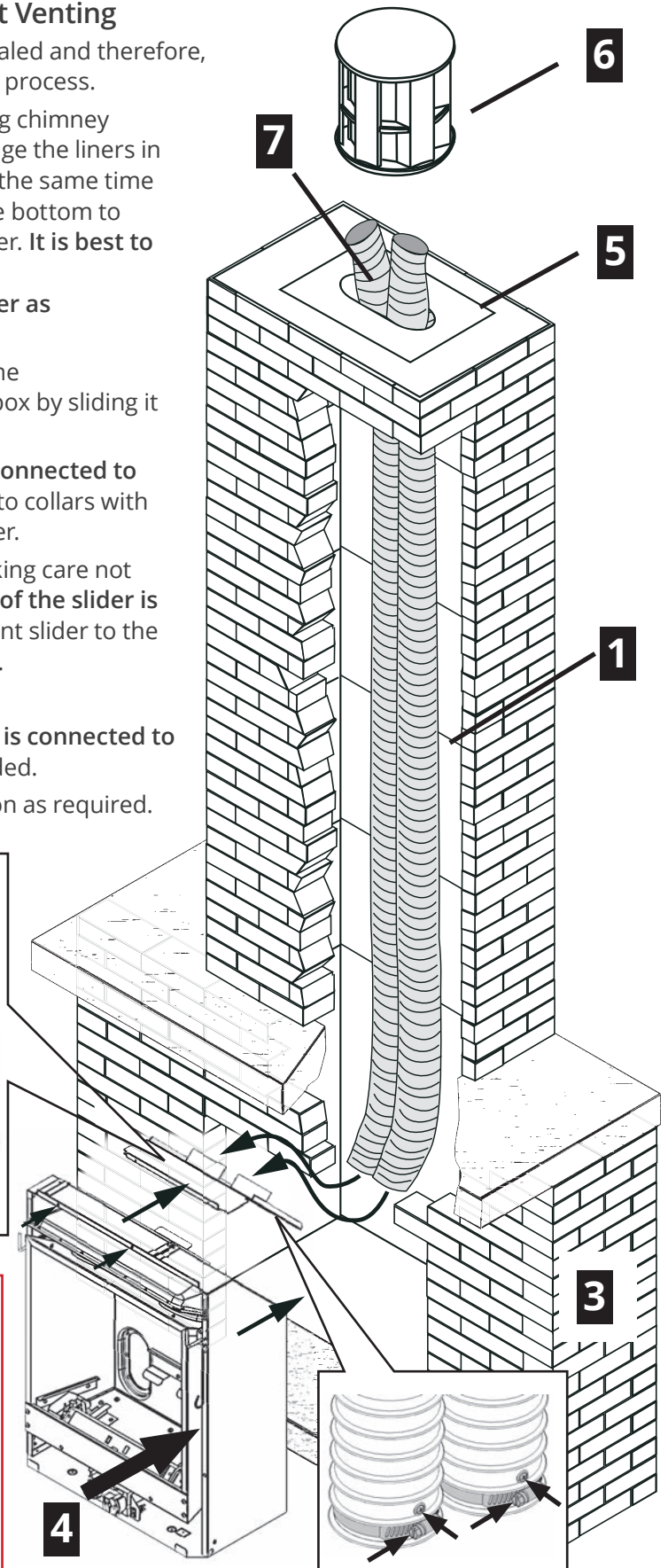
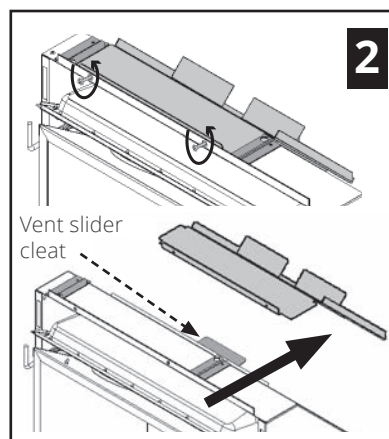

### **⚠ WARNING**

**Failure to position the parts in accordance with these diagrams or failure to use only parts specifically approved with this appliance may result in property damage or personal injury.**

# Installation

## Venting

### Co-Axial Applications (3" x 5" liners using 590FVK2 and 530CVA2)—Connect Venting

IMPORTANT: This appliance's venting system is room sealed and therefore, does not require room air to be used in the combustion process.

1. Stretch 3" and 5" liners from kit 590FVK2 individually to required length. Insert the 3" liner inside the 5" liner and rough-in vent liners into the existing chimney system from the roof. Be careful not to tear or damage the liners in the process. Verify there is plenty of liner at the bottom to facilitate the connection of the liners to the vent slider so you will not need to stretch more later.
2. Trim 590FVK2's Terminal Adapter & Flashing as required to suit top of chimney and fold a drip edge if desired.
3. Trim ends of liner if necessary and fasten to collars on the underside of the 590FVK2's terminal adapter using sheet metal screws and gear clamps provided.
4. Apply a bead of sealant to top of chimney and seat 590FVK2's flashing onto sealant.
5. Release the two screws retaining the vent slider to the front of the firebox. Remove the slider from the firebox by sliding it towards the back of the firebox.
6. Fit the two liners. Secure with hose clamps (included) and 2 tapping screws per liner (inner liner first, then outer).
7. Slide the firebox onto the vent slider in the cavity taking care not to damage the liners. **Make sure that the rear edge of the slider is hooked over the cleat on the firebox.**

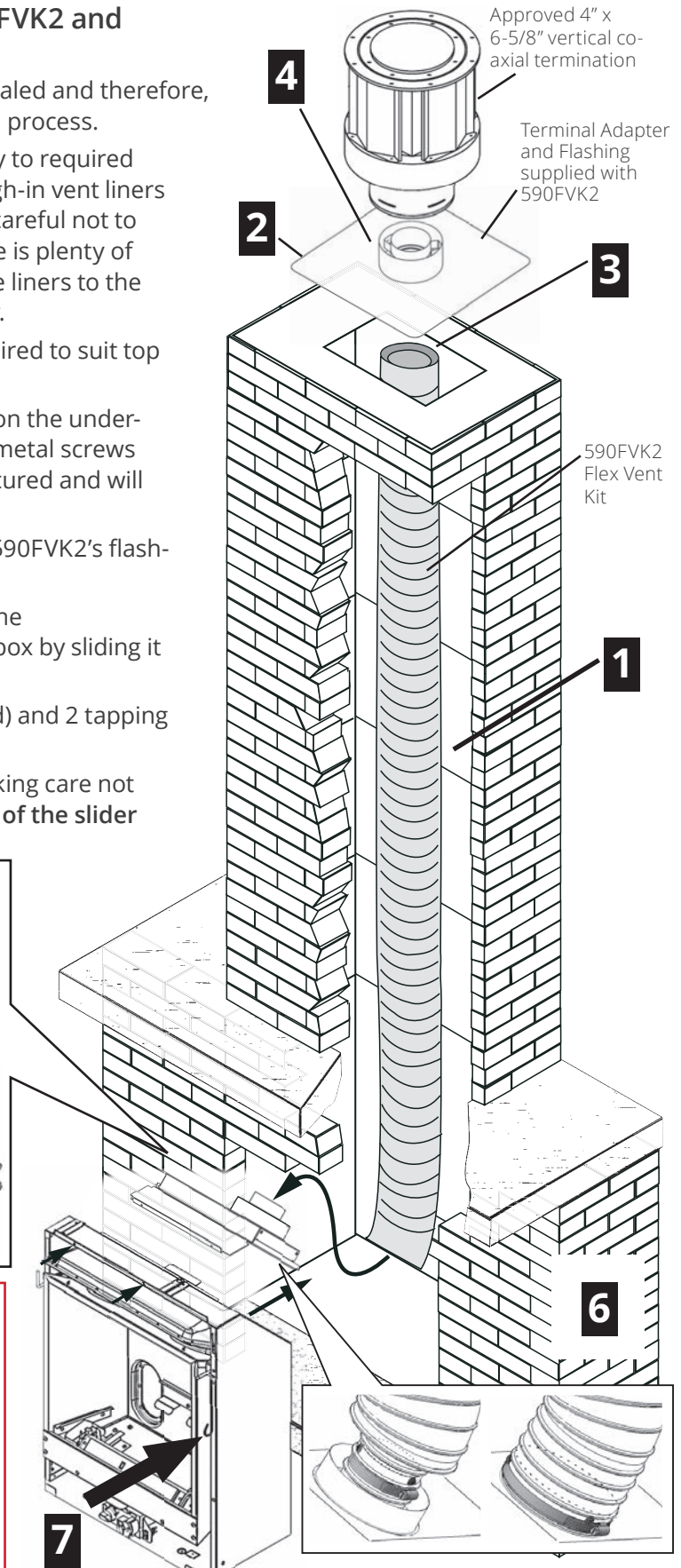
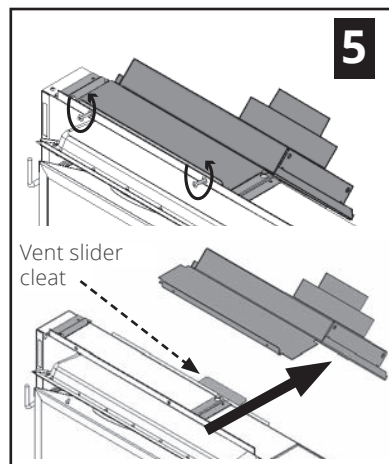

### **WARNING**

Failure to position the parts in accordance with these diagrams or failure to use only parts specifically approved with this appliance may result in property damage or personal injury.

# Installation

## Gas Supply

### Connect Gas Supply

It is preferable to rough-in the gas line at this point before proceeding with the firebox installation.

The appliance is supplied for supply gas connection at the control valve. Supply line connection to the control valve of the appliance is 3/8" NPT female. Take care not to apply torque to the valve. An isolation valve may be fitted within the appliance case. Be aware that the supply pipe should follow routing to clear the remote receiver or optional fan.

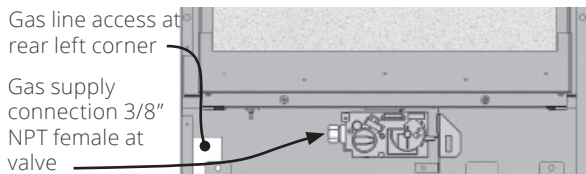

Use only new black iron or steel pipes, CSST, or copper tubing if acceptable—check local codes. **Note that in USA, copper tubing must be internally tinned for protection against sulfur compounds.**

Union in gas lines should be of ground joint type.

The gas supply line must be sized and installed to provide a supply of gas sufficient to meet the maximum demand of the appliance without undue loss of pressure.

Sealant used must be resistant to the action of all gas constituents including propane gas. Sealant should be applied lightly to male threads to ensure excess sealant does not enter gas lines.

The supply line should include a manual shut-off valve and union to allow the appliance to be disconnected for servicing.

### Pressure test the supply line for leaks.

The appliance and its individual shut-off valve must be disconnected from the gas supply piping system during any pressure testing of that system at test pressures in excess of 1/2 psig (3.5kPa).

The appliance must be isolated from the gas supply piping system by closing its individual manual shut-off valve during any pressure testing of the gas supply piping system at test pressures equal to or less than 1/2 psig (3.5kPa).

Failure to either disconnect or isolate the appliance during pressure testing may result in regulator or valve damage. Consult your dealer in this case.

The minimum supply pressure is given on page 6 of this manual.

All piping and connections must be tested for leaks after installation or servicing. All leaks must be corrected immediately.

### When testing for leaks:

- Make sure that the appliance is turned off.
- Open the manual shut-off valve.
- Test for leaks by applying a liquid detergent or soap solution to all joints. Bubbles forming indicate a gas leak.



### WARNING

**NEVER USE OPEN FLAME to check for leaks. Correct any leak detected immediately.**

The pressure test tapping locations are shown below. A built-in non-adjustable regulator controls the burner manifold pressure. The correct pressure range is shown page 6 of this manual. The pressure check should be made with the burner alight and at its highest setting. See *Appendix A – Lighting Instructions Plate on page 35* for full operating details.

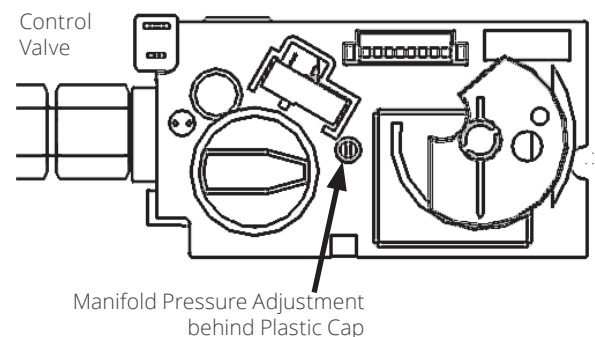
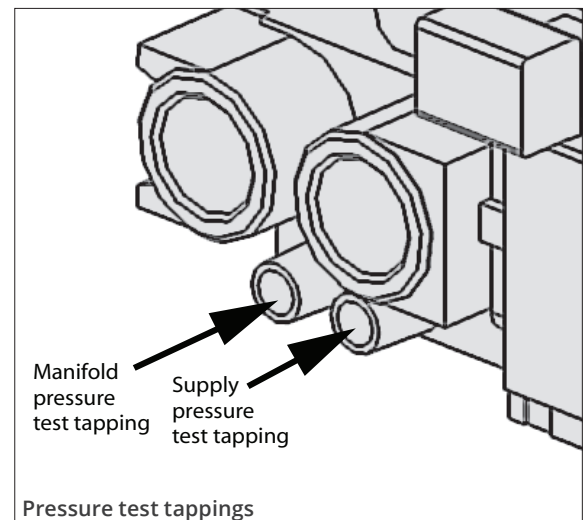



# Installation

## Liners Panels—Traditional Logs & Coals

### Install Ceramic Liners (Logs or Coals only)

The 530LSK and CSK fuel beds include a set of reversible liners. Check with the consumer which side must be visible and follow the instructions below to install the liner set.

- **530RSK Rock Set liners.** For ceramic liners installation with the 530RSK, see **Rock Set and Liners 530RSK** in Fuel Beds section in this manual.
- **530DWK Driftwood Kit liners.** For ceramic liners installation with the 530DWK, see **Driftwood and Liners 530DWK** in Fuel Beds section in this manual.
- **580RGL Reflective Glass Liner Set.** To install the 580RGL, see the installation instructions provided with the kit.
- **567FGP Top Grille.** At this point, you can install the 567FGP, if used (logs, rocks or driftwood versions only). The 567FGP Top Grille is sold separately except when included with front trim—see front trim installation manual.

1. Locate the ceramic rear wall in the channel at back of the firebox and flat against the back of the firebox.
2. Locate the sidewalls in the channels at the sides of the firebox.
3. Remove two screws from under the top front of the firebox. Using these screws fit the port cover.

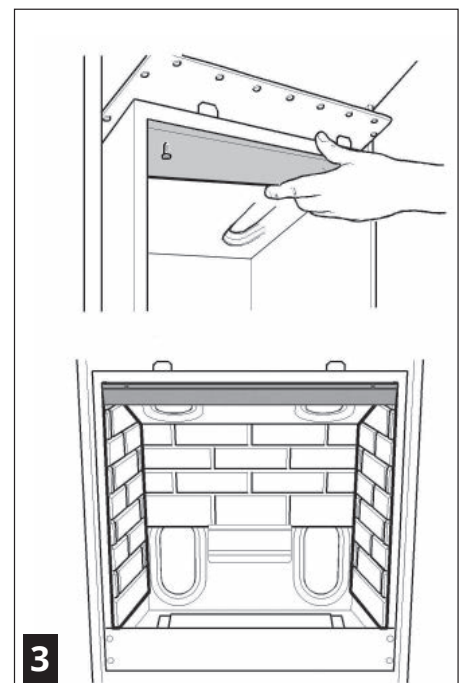
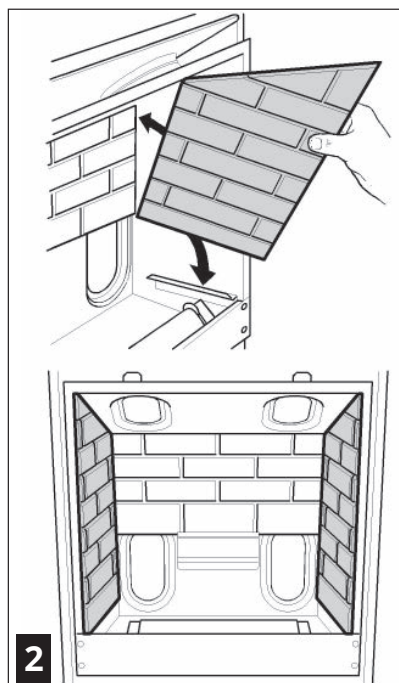
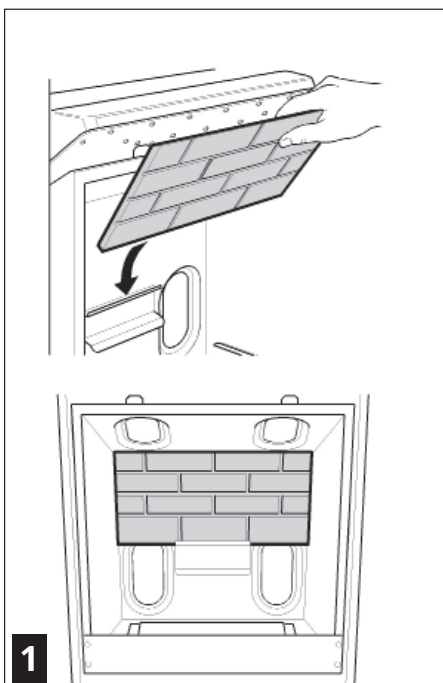

# Installation

## Fuel Beds

### Traditional Logs Set 530LSK

1. Place the base log on the supports in the firebox and against the support at the firebox back.
2. Locate the rear upper log on the two ceramic pins at the rear of the base log.
3. Place the front log behind the metal strip at the front of the firebox.
4. Locate the right middle log on the pin in the right hand side of the base log.
5. Locate the left side log on the ceramic pin on the left hand side of the base log. Rest the narrow nose of this log on the projection at the front center of the base log—ensure that the narrow nose does not rest on the burner.
6. Locate the right side log on the pin in the front log and rest the nose of this log on the projection on the base log—ensure that the nose does not rest on the burner.

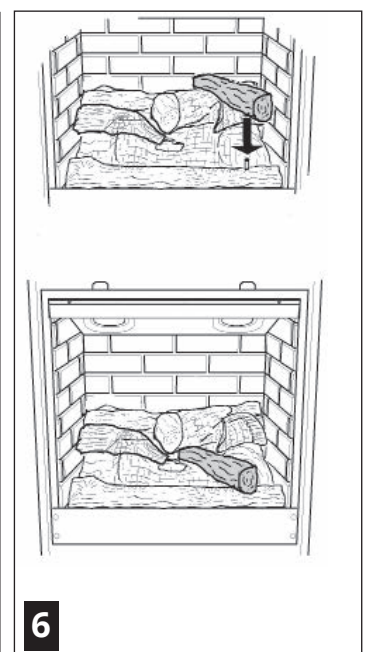
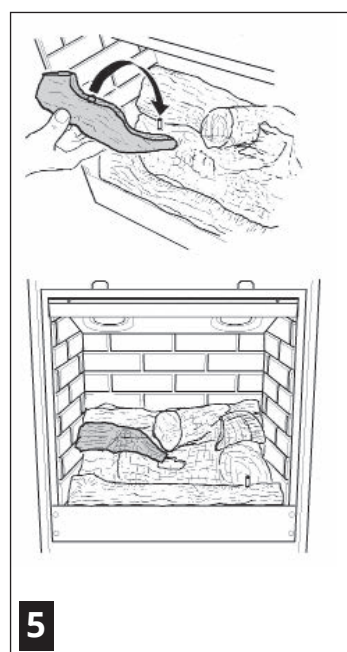
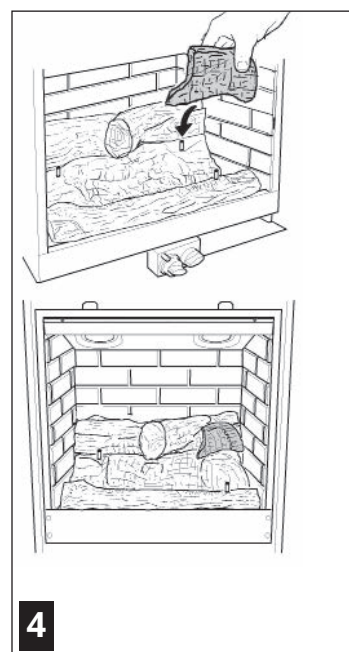
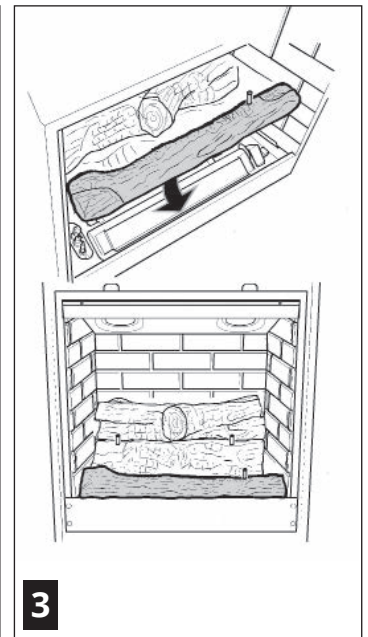
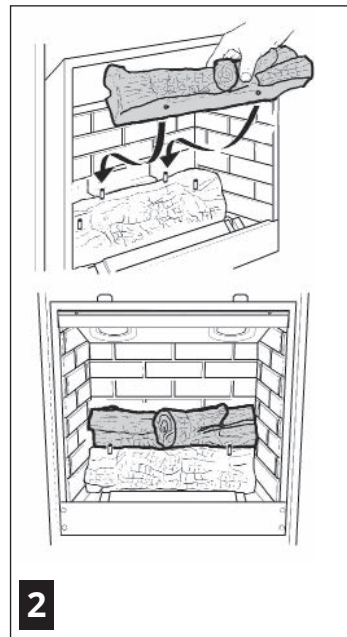
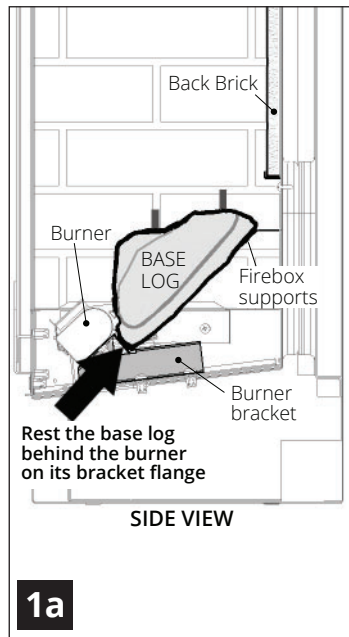
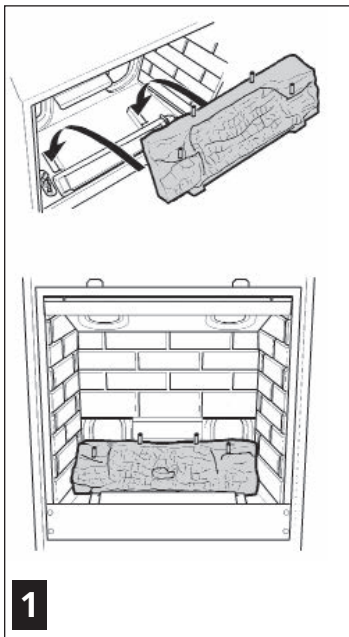

# Installation

## Fuel Beds

### Coal Set 530CSK

1. Place the base coal on the supports in the firebox and against the firebox back.
2. Place the left front coal in position behind the metal lip at the front of the firebox. The side projection on this coal should be near the middle front of the firebox.
3. Place the right front coal behind the metal lip at the front of the firebox. Its left side should rest over the projection on the left front coal.
4. The center right coal has letter "R" embossed underneath. Place this coal behind the front right coal.
5. The center left coal has letter "L" embossed underneath. Place this coal behind the front left coal.

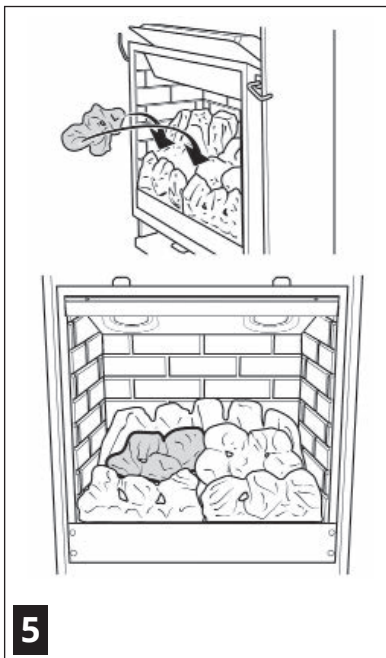
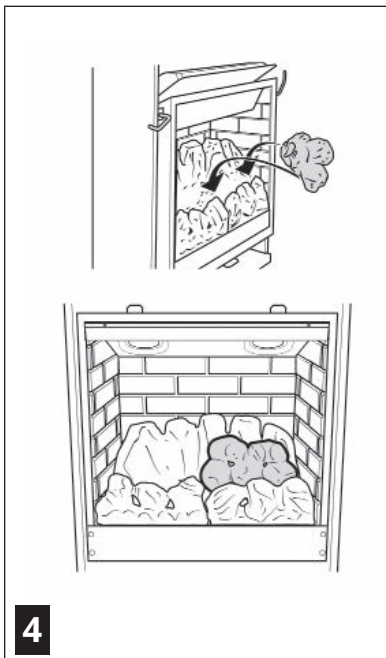
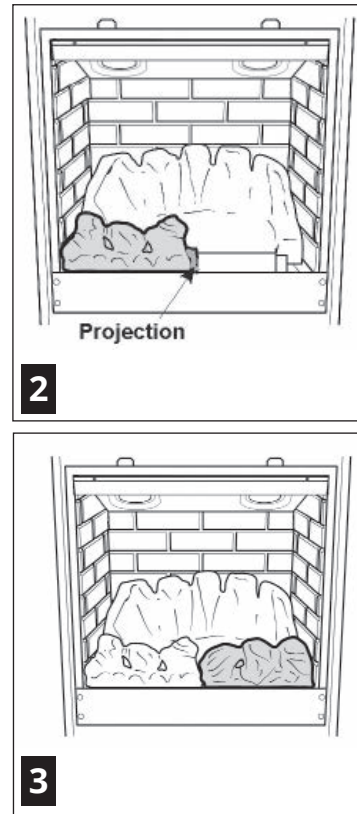
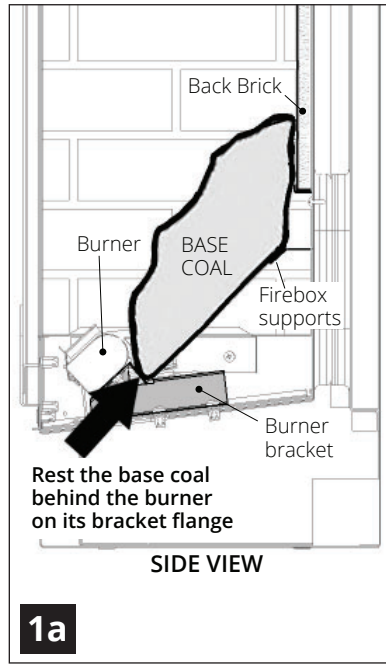
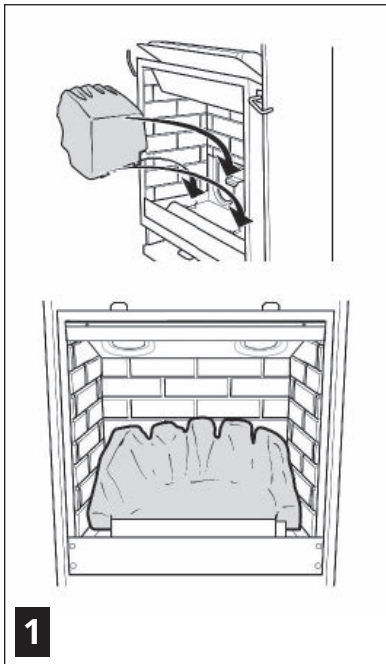



# Installation

## Fuel Beds

### Rock Set and Liners 530RSK

Unpack each piece of the ceramic rock set carefully to avoid damages. The set contains:

- Ceramic platform
- Left and right side reversible ceramic panels
- Rear panel support
- Rear fluted panel
- Ceramic base for rocks
- 12 ceramic rocks

**580RGL Reflective Glass Liner Set.** To install the 580RGL, see the installation instructions provided with the kit.

### Install liners

1. Remove the rear panel support inside the firebox (3 screws).
2. Replace with the rear panel support provided with the 530RSK kit and fix it (3 screws).  
**If installing the 567FGP Top Grille (sold separately), fit it now.** See instructions supplied with the grille.

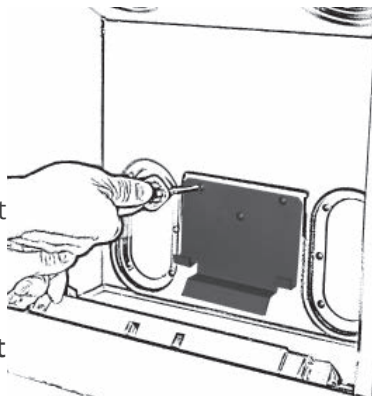

3. Place the rear panel on the rear support as indicated. Hold in place and go to next step.

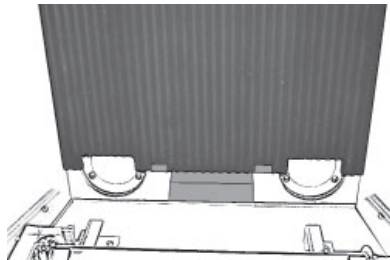

4. Place the left and then the right panels in the firebox showing the black fluted sides.

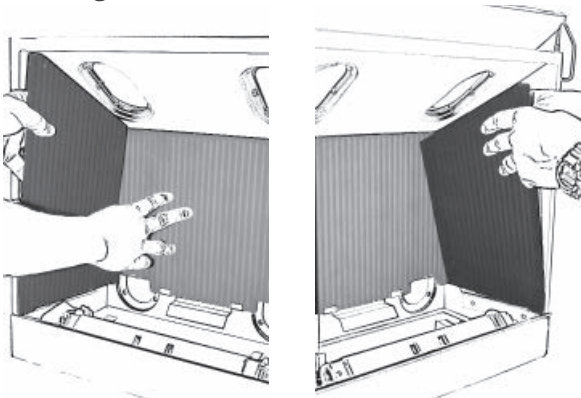

### Install rock base & platform

1. Place the rock base behind the burner. The two protrusions in front of the base should rest on the burner mounts as indicated.

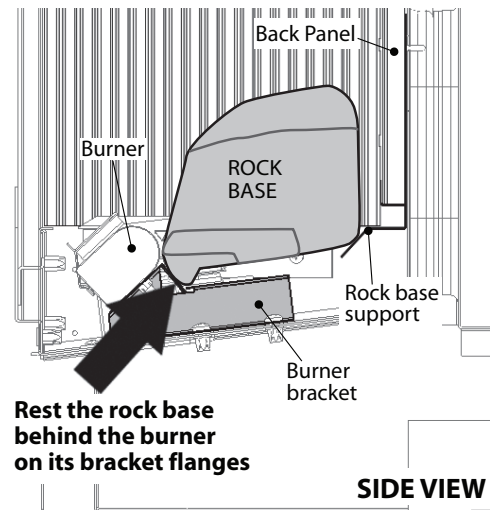
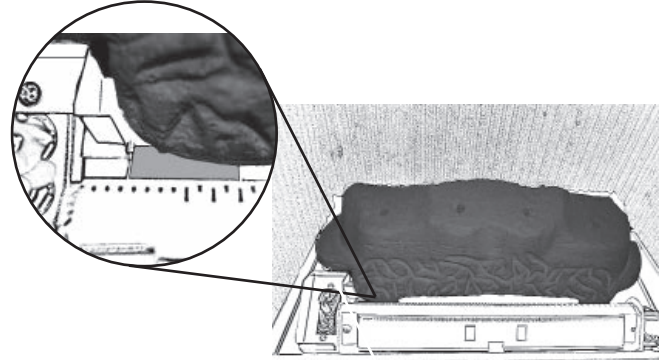

2. Place the ceramic platform over the burner and around the rock base with the pegs on the top. The rear part of the platform should overlap the edges of the rock base on each side.

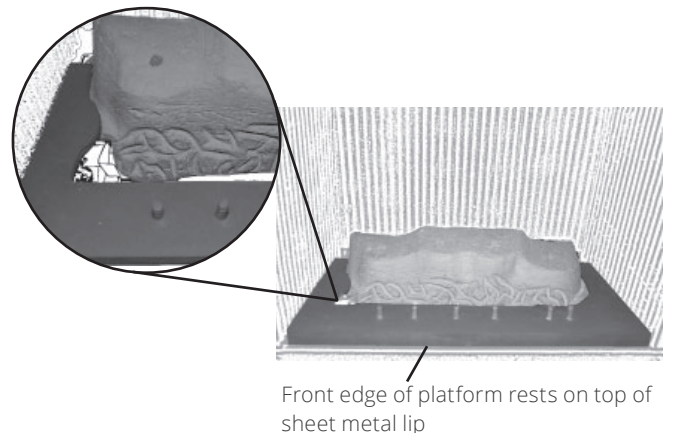



# Installation

## Fuel Beds

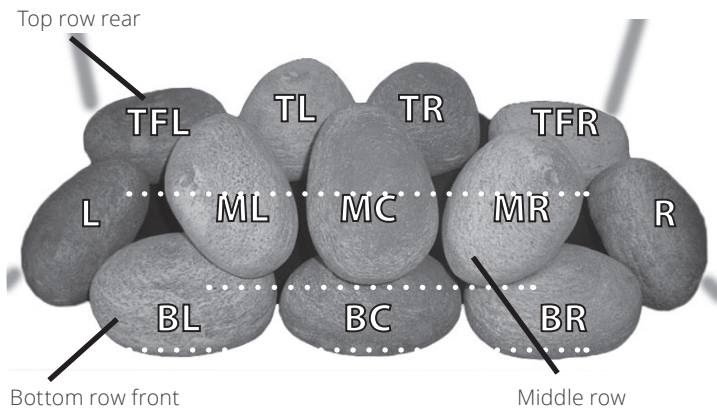

### Install rocks

To get the optimal flame effect, it is important to place the rocks in their appropriate position. Each rock is embossed underneath with letters and an arrow indicating the position of the rock. **The arrows point to the front of the fireplace when the rock is installed.** See the image and table at the top of the page to help you with the identification and position of the rocks.

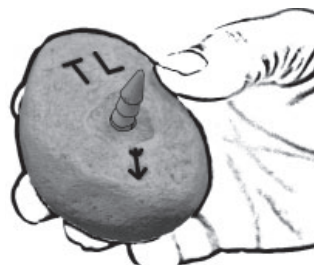

1. Identify the rocks **TFL, TL, TR, and TFR**. These rocks have pegs that fit in the holes on the top of the rock base. Install these rocks positioning them so that the arrow embossed underneath point to the front of the fireplace.
2. Identify the rocks **BL, BC, and BR**. These rocks have two holes that fit on the pegs of the ceramic platform. Install these rocks positioning them so that the arrow embossed underneath point to the front of the fireplace.

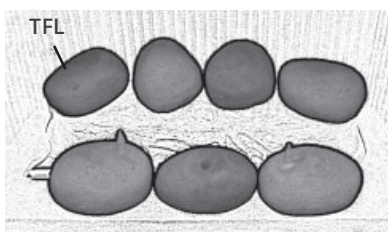
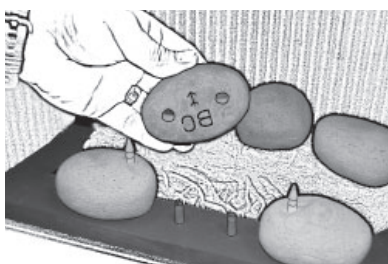

3. Identify the rocks **ML, MC, and MR**. Those rocks have pegs that fits in the holes on the top of the rocks on the front row. Install those rocks positioning them so that the arrows underneath point to the front of the fireplace.

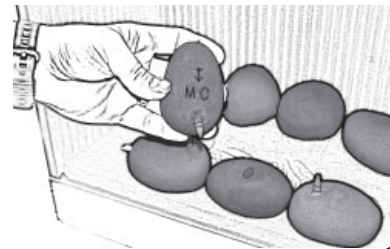

This rock is held by a peg and does not touch the rocks of the back row

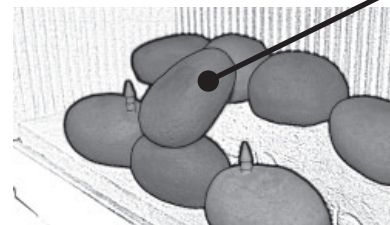

4. Identify the rocks **L and R**. Those rocks don't have any peg or hole. Install those rocks as indicated, at the left and right of the rock pile positioning them so that the arrows underneath point to the front of the fireplace. The rock rests against the other rocks and is at an angled position. *Make sure that the TFL rock at the rear left is in the proper angle*—see image in step 2. See the image at the top of the page.

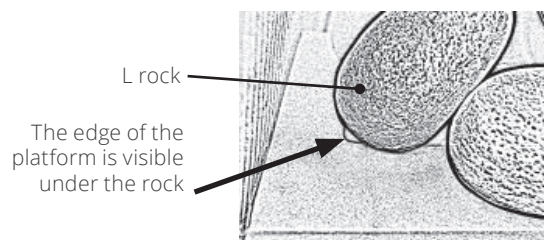

You must be able to see the edge of the platform under the L rock as indicated at left.

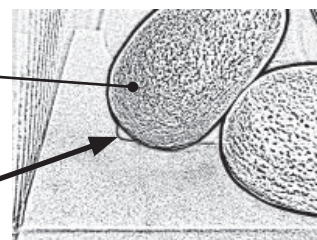

Rock ID	Description	Other markers	Position in the firebox
TFL	Top far left	1 peg under	Top row rear
TL	Top left	1 peg under	Top row rear
TR	Top right	1 peg under	Top row rear
TFR	Top far right	1 peg under	Top row rear
BL	Bottom left	2 holes under, 1 peg above	Bottom row front
BC	Bottom center	2 holes under, 1 hole above	Bottom row front
BR	Bottom right	2 holes under, 1 peg above	Bottom row front
ML	Middle left	1 hole under	Middle row
MC	Middle center	1 peg under	Middle row
MR	Middle right	1 hole under	Middle row
L	Left	—	Left side
R	Right	—	Right side

# Installation

## Fuel Beds

### Driftwood Kit and Liners 530DWK

Unpack each piece of the ceramic driftwood set carefully to avoid damages. The set contains:

- Metal platform
- Left and right side reversible ceramic panels
- Rear panel support
- Rear fluted panel
- 5 driftwood logs
- 4 ceramic pebbles

**580RGL Reflective Glass Liner Set.** To install the 580RGL, see the installation instructions provided with the kit.

### Install liners

1. Remove the rear panel support inside the firebox (3 screws).

2. Replace with the rear panel support provided with the 530DWK kit and fix it (3 screws).

**If installing the 567FGP Top Grille (sold separately), fit it now.** See instructions supplied with the grille.

3. Place the rear panel on the rear support as indicated. Hold in place and go to next step.

4. Place the left and then the right panels in the firebox showing the black fluted sides.

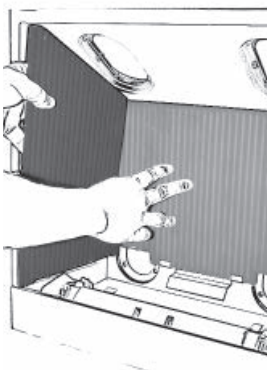
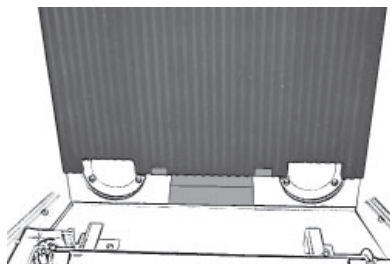
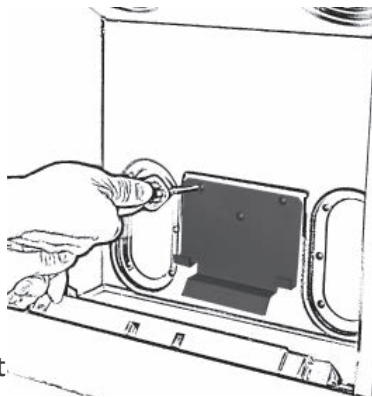

### Install platform, driftwood logs and pebbles

1. Place the protrusion at the back of the base log on the ledge of the rear panel support as far back as it will go. Then pull the log evenly towards the front until it rests against the burner supports.

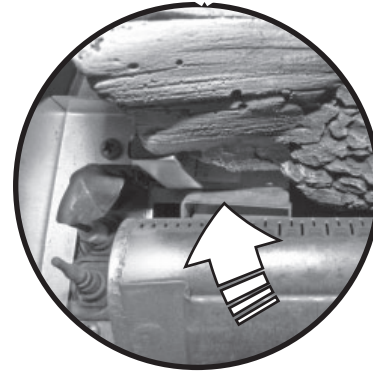
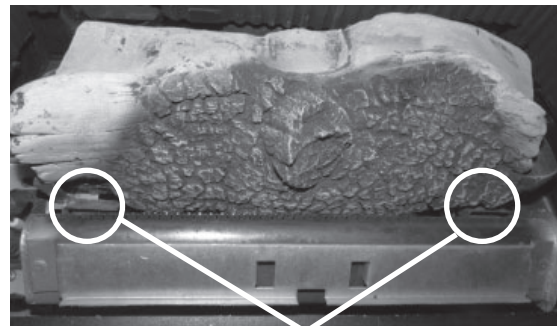
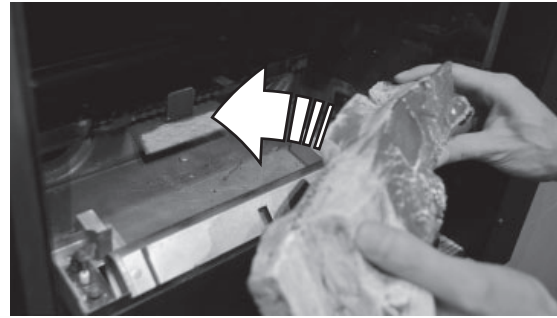

2. Place the metal platform and centre it over the burner and around the base log with the pegs on the top. The front of the platform must rest on the edge of the firebox. The right end rests of the base log.

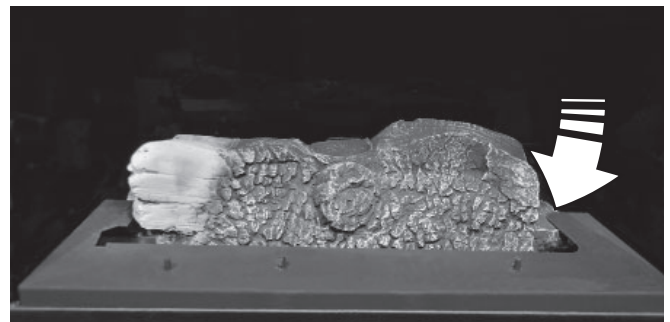



# Installation

## Fuel Beds

3. Place the rear log on top of the base log locating it into the notches on top of the base log.

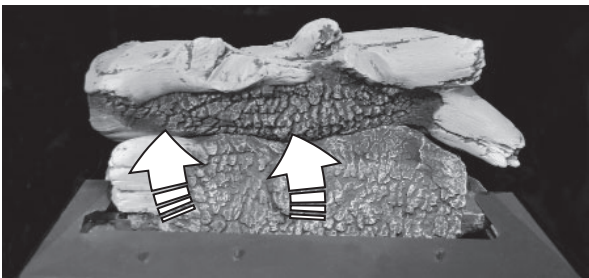

4. Place the centre log on the platform inserting the peg into the hole on the log as indicated. Line up the log parallel to the platform.

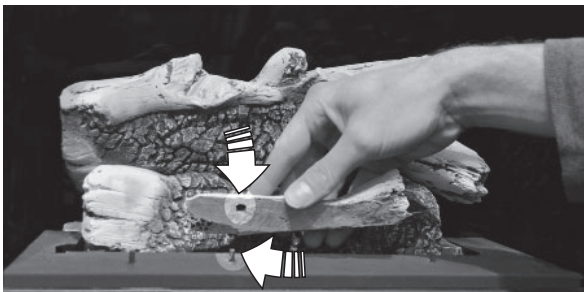

5. Place the right log inserting the platform peg into the hole at the end of the log; rest the upper end of the log in the notch on the rear log as indicated.

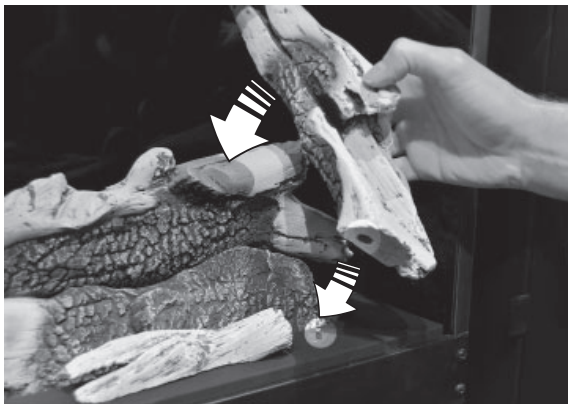

6. Place the left log inserting the platform peg into the hole at the end of the log; rest the upper end of the log in the notch on the rear log as indicated.

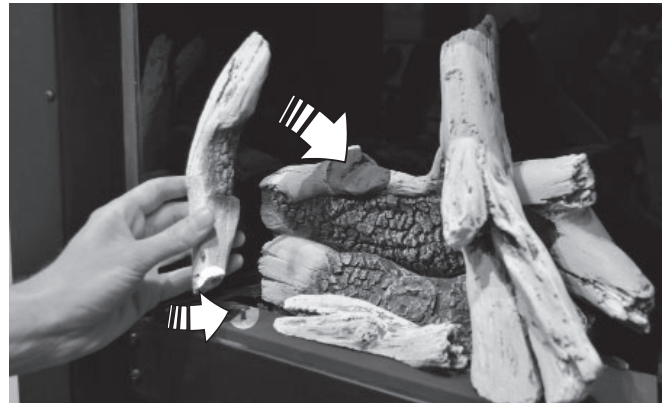

7. Place one larger pebble on each end of the platform to cover its edge as indicated; place the smaller pebbles on the platform in front the larger ones as indicated.



# Installation

## Refit & Check Window

### Refit and Check Window

1. Rest the window on the support at the base of the firebox and center it on the width.
2. While pressing the window against the firebox, pull the clamping bars levers forward and rotate them inwards to secure the top of the window.
3. Fit the two spring-loaded bolts through the bottom of the window and tighten to secure the window.
4. Pull the top of the window forward and release to check that it opens slightly and returns confirming the good function of the spring-loaded mechanism.

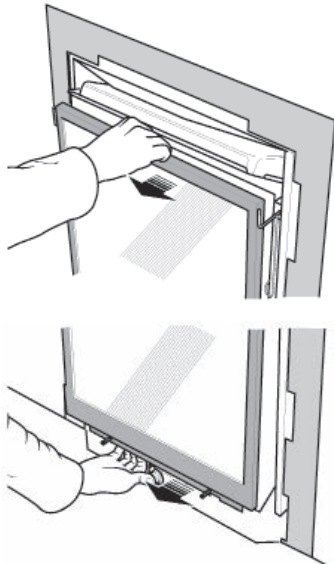
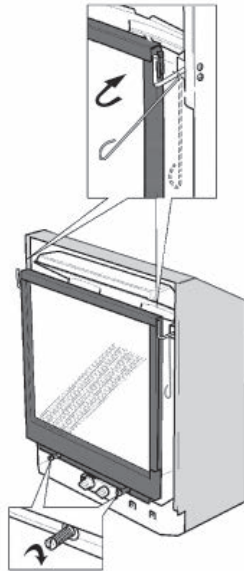

5. Similarly, check the bottom of the window by pulling it forward and releasing it.
6. Apply firm pressure around the window frame to ensure the window is sealed tight against the firebox.
7. If the Hot Glass Warning plate has been removed from the front lower corner of the window, re-install it by sliding it between the glass and the frame as indicated.

### **WARNING**

The window unit must be correctly installed, fastened and sealed after servicing or serious bodily injury and/or damage to the appliance may result.

To ensure a safe operation:

- Double-check that the window frame is correctly installed;
- Verify that the levers and spring-loaded bolts are hooked properly to the window tabs then;
- Pull out the top of the window and release it to ensure the springs return it; repeat with the bottom of the window;
- Ensure the window is sealed before operation.

### **WARNING**

Failure to install the window correctly can:

- Leak carbon monoxide;
- Affect the performance of the fireplace;
- Damage components;
- Cause overheating resulting in dangerous conditions.

Damages caused by incorrect window installation is not covered by the Valor warranty.

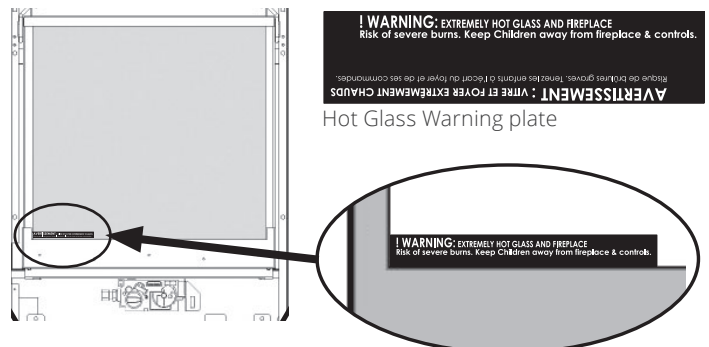

# Installation

## Battery Holder

### Install Battery Holder

The batteries that power the receiver and handset need to be installed prior to pairing and use.

1. Take the receiver out from under the firebox.
2. Insert four 1.5 V high quality **alkaline** batteries in the battery holder and one high quality **alkaline 9 V** battery in the remote handset. The battery holder and cable are supplied with the appliance.



3. Connect the cable to the receiver as shown.

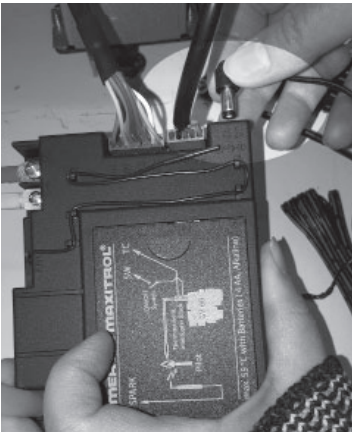

4. Connect the other end of the cable to the battery holder.

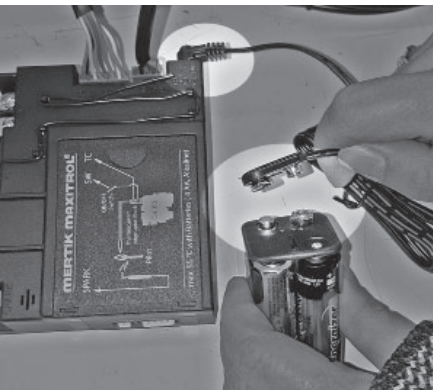

5. Place the receiver and battery holder as shown below (placement may vary with installed options).

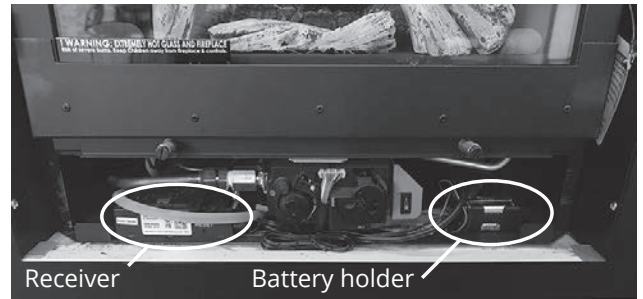

6. Use a heat-resistant tie to gather any extra cable between the receiver and the holder.

### ⚠ Caution

DO NOT let the cable touch the burner plate above, it will melt during operation.

# Installation

## Remote Control Pairing

### Synchronize Receiver and Handset

The receiver and handset of the remote control system must be initially paired before the first use.

1. If not already done, place a 9 V **alkaline** battery in the handset.
2. Identify the RESET button on the front of the receiver.
3. With a thin object, press and hold the receiver's reset button until you hear one short and one long beep. Release the button after the second beep.
4. Within the next 20 seconds, press the small flame button (  ) on the handset until you hear two short beeps confirming the pairing is set.  
If you hear a long beep, the pairing has not been done or the wires are not connected correctly.

This is a one time setting only and is not required when changing the batteries in the remote handset. The remote control system is now ready to use.

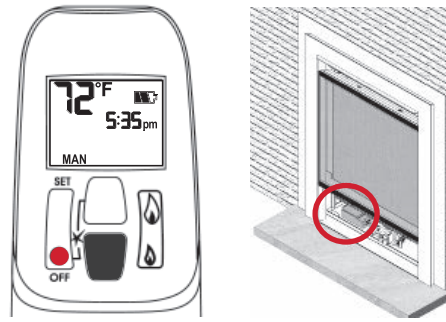



# Installation

## Burner aeration

### Check Operation

Turn the fireplace flame up and down using the remote control to confirm that the full range of inputs is achieved—see Appendix B – Remote Control Operation pages 36–39 for details.

### Adjust Aeration (if needed)

Light the fire and allow the unit to warm up for 10–15 minutes to evaluate the flame picture. Burners are equipped with an adjustable shutter to control primary aeration. See figures below. The shutter is factory-set to an aeration gap which will give optimum performance for the vast majority of installations.

In some installations, depending of the fuel bed used, the altitude and other considerations, the flame picture may be improved by adjusting the aeration. The need for adjustment should be determined only by operating the appliance with the fuel bed and window installed and evaluating the flame picture after a 15-minute warm-up.

**Increasing aeration (open)** will cause the flames to appear more transparent and blue showing more ceramic effects glow.

**Decreasing aeration (close)** will cause flames to appear more yellow or orange showing less ceramic effects glow.

*Too little aeration may result in black carbon forming and dropping into the firebox.*

### Air Shutter

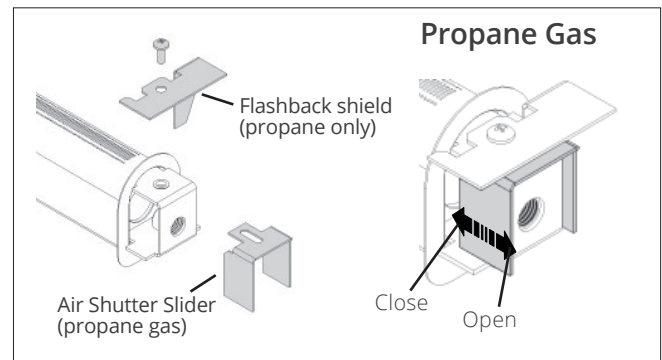
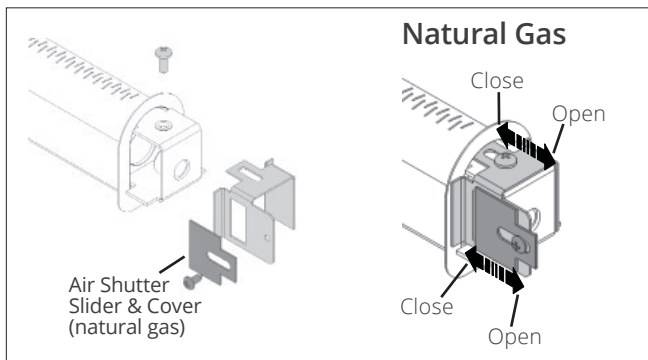

## Front and Barrier Screen

Install the front chosen by the customer for the fireplace. Install as well the barrier screen which is provided with the front.

Show the customer how to access the controls when the front is installed and how to remove it.

Follow the instructions provided with the front and leave those instructions behind for the customer's further reference.

## Handset Wall Holder

The remote control kit for this fireplace comes complete with a wall-mounted holder. This holder is not required in all installations but is provided as an optional feature for those customers who wish to mount the remote handset to the wall.

To install the holder to the wall, find a convenient location and use the hardware provided with the kit. See the diagram below for required hardware and configurations. Note that the holder can be installed at the base of a light switch plate.

**IMPORTANT.** The location of the remote control handset is important to insure proper temperature regulation. To obtain a constant temperature, we recommend that the handset should be between 3 and 15 feet away from the appliance but not directly above it. We also advise that the handset should be located away from any other heat source and not in direct sunlight as this may affect the temperature sensor located in the remote handset.

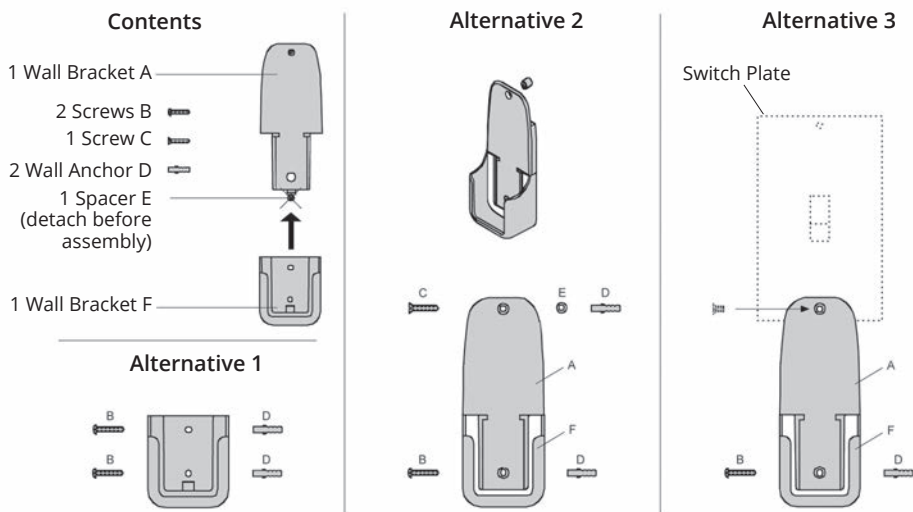



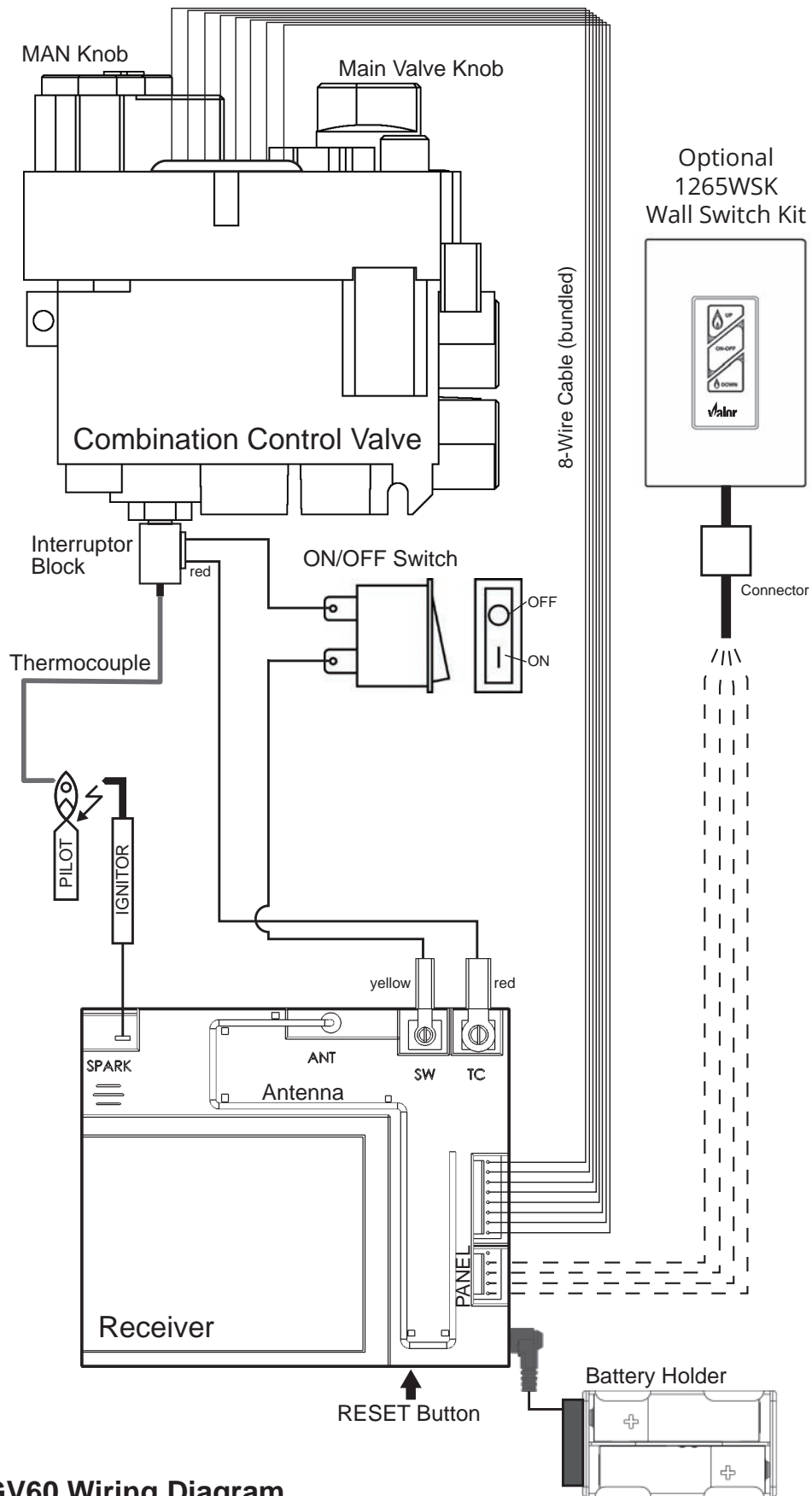

# Wiring Diagram



GV60 Wiring Diagram

# Approved Venting Components

Approved Direct Vent Suppliers for Valor Models 530INI/IPI insert engine ONLY										
  Venting Parts Description		Venting Parts Code / availability by Manufacturer								
		DURA-VENT	SELKIRK	ICC EXCEL DIRECT	SECURE VENT	RLH INDUSTRIES	AMERIVENT	MILES INDUSTRIES	BDM	
Termination Caps	Vertical	Standard Co-axial	46DVA-VC	4DT-VT	—	—	HSDV4658-1313	4DVC	—	940264
								4DH-1313		940364
										940206LP
		High Wind Co-axial	46DVA-VCH	—	TM-4SVT	SV4CGV	—	—	—	—
		Extended Co-axial	46DVA-VCE	—	—	—	—	—	—	—
	Vertical	Co-linear	—	—	TM-IVT	3PDVCV	HS-C33U-99	HCL-99-33	559CLT	940033B
							HCL-913-33	940034B		
HS-C33F-1313	HCL-1313-33		940033HWS							
			940033RD							
Horizontal		—	—	—	—	—	—	720SWK <sup>3</sup>	—	
Vent Adapters / Couplers		Universal Adapter 3" Flex Coupler	2150	—	TM-CFAA3	—	—	—	—	95090390
		Co-linear Flex Connector	46DVA-ADF	—	—	—	—	—	—	—
		Co-linear-to-Co-axial Adapter	46DVA-GK 46DVA-CLTA	—	TM-4CTA	—	—	4DCAT33	530CVA2	—
		Co-axial Adapter 5 x 3 to 6-5/8 x 4	—	—	—	—	—	—	590FVK2 (incl. flashing)	—
Aluminum Flexible Liner		3" or 4" diameter	NOTE: 2-ply liner approved to CAN/ULC S635 suitable for venting gas appliances. As manufactured by Z-Flex, Flexmaster and others.							
		Co-Linear	2280 Series	AF3-35L	TM-ALK33	—	—	—	—	952703
					TM-ALT33	—	—	—	—	952704
		Co-Axial 5" x 3"	—	—	—	—	—	—	590FVK2	—
Flashings		Roof Flashing 0/12-6/12	46DVA-F6	4DT-AF6	TF-4FA	SV4FA	—	4DF (0/12-5/12)	—	949606012
		Roof Flashing 7/12-12/12	46DVA-F12	4DT-AF12	TF-4FB	SV4B	—	4DF12 (6/12-12/12)	—	949606712
		Flat Roof Flashing	46DVA-FF	—	TF-4F	SV4F	—	—	—	949606001
		Masonry Flashing	—	—	TF-4MF	—	—	—	559FSK	—

- Notes:**
1. Follow instructions supplied with each manufacturer's components.
  2. Termination caps manufactured by RLH Industries or American Metal Products are from Homestyle Chimney Collection and can be ordered in one of the following finishes: a) aluminum; b) black powder coated; c) solid copper.
  3. The 720SWK Sidewall Kit can only be installed on the 530INI/IPI insert engines (logs, rocks and driftwood only).

# Appendix A – Lighting Instructions Plate

## FOR YOUR SAFETY, READ BEFORE LIGHTING

**WARNING:** If you do not follow these instructions exactly, a fire or explosion may result causing property damage, personal injury or loss of life.

- A. This appliance has a pilot which must be lighted by hand or by remote control. Follow these instructions exactly. To save gas, turn the pilot off when not using the appliance for a prolonged period of time.
- B. **BEFORE LIGHTING**, smell all around the appliance area for gas. Be sure to smell next to the floor because some gas are heavier than air and will settle on the floor.
- WHAT TO DO IF YOU SMELL GAS
- Do not try to light any appliance.
  - Do not touch any electric switch; do not use any phone in your building.
  - Immediately call your gas supplier from a neighbor's phone. Follow the gas supplier's instructions.
  - If you cannot reach your gas supplier, call the fire department.
- C. Use only your hand to push in or turn the control knobs. Never use tools. If the knobs will not push in or turn by hand, **don't try to repair them; call a qualified service technician. Force or attempted repair may result in a fire or explosion.**
- D. Do not use this appliance if any part has been under water. **Immediately call a qualified service technician** to inspect the appliance and to replace any part of the control system and any gas control, which has been under water.

## LIGHTING INSTRUCTIONS

1. STOP! Read the safety information above. Dependent on model, switch #1 may be mounted directly to valve see Fig 2A.

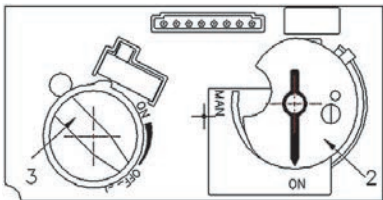

Fig 1

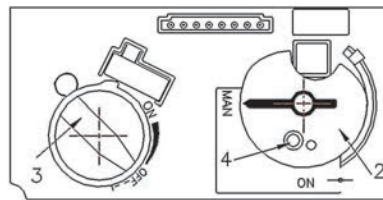

Fig 2

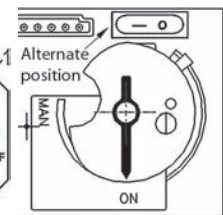



Fig 2A

2. SET ON/OFF SWITCH (1) TO "OFF" POSITION.

- Wait five (5) minutes to clear out any gas, then smell for gas, including near the floor. If you smell gas, STOP! Follow "B" in the safety information above on this label. If you don't smell gas, go to the next step.
3. AUTOMATIC IGNITION (fig. 1): Locate the pilot (fig 3.) inside of firebox at Left Hand side.
- ON/OFF switch (1) in ON position, MAN-knob (2) in ON position; set Flame Adjustment knob (3) to lowest setting (⌚);
  - On the remote control handset, press and hold the 'off' button and  (large flame) simultaneously; a short acoustic signal confirms the start has begun;
  - Further short acoustic signals indicate the ignition process is in progress;
  - When the pilot is lit, the Flame Adjustment knob (3) will automatically rotate to the highest setting.
  - Press the  (small flame) on the remote control handset to reduce the flame height.

4. MANUAL IGNITION (fig. 2): With the window off, locate the pilot (fig. 3) inside of firebox at Left Hand side;

- ON/OFF switch (1) in ON position, MAN-knob (2) in MAN position;
  - Set Flame Adjustment knob (3) to the lowest setting (⌚);
  - Push down the metallic core (4) with a pen or similar instrument; this will establish the pilot gas flow;
- Light gas at the pilot (5) with a match;
- Continue holding down metal core (4) for about 10 seconds; after release, pilot should remain lit;
- If the pilot will not stay lit after several tries, turn the gas control knob (3) to "OFF" (⌚) and call your local service technician or gas supplier.

Reinstall the window and set the MAN-knob (2) to "ON"; turn Flame Adjustment knob (3) up (⌚) or down manually or use the up/down 'flame' buttons on the remote control handset to adjust the flame height.

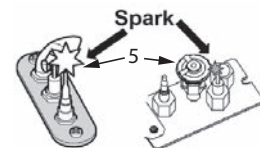



Fig 3

## TO TURN OFF GAS TO APPLIANCE

1. AUTOMATIC SHUT-OFF (using the remote control handset):
- Press and hold the  (small flame) on the remote control handset to shut-off the main burner gas flow;
  - Press "OFF" button on remote handset to shut-off the appliance, including pilot flame.
2. MANUAL SHUT-OFF (using only the ON/OFF switch (1))
- Press "O" the ON/OFF switch (1) to shut-off the appliance.

# Appendix B – Remote Control Operation

## Radio Frequency

315 MHz for USA and Canada.

This device complies with Part 15 of the FCC Rules and with Industry Canada license-exempt RSS standard(s). Operation is subject to the following two conditions:

- (1) this device may not cause harmful interference, and
- (2) this device must accept any interference received, including interference that may cause undesired operation.

**NOTE: Before using the remote control system for the first time,** the receiver and the handset must be synchronized. See *Remote Control Pairing* in this manual.

**IMPORTANT: BEFORE YOU BEGIN,** please note that on this system, the settings of time, temperature and automatic ON/OFF **can only be programmed when the function display is flashing.** Be patient when programming as it can take a few seconds to set.

Note: In the TEMP or TIMER modes, the remote handset senses the room temperature and adjusts the flame accordingly.

To communicate, the handset should be within 15 feet (4.5 meters) of the fireplace.

**Do not leave the handset on the mantel or hearth.**

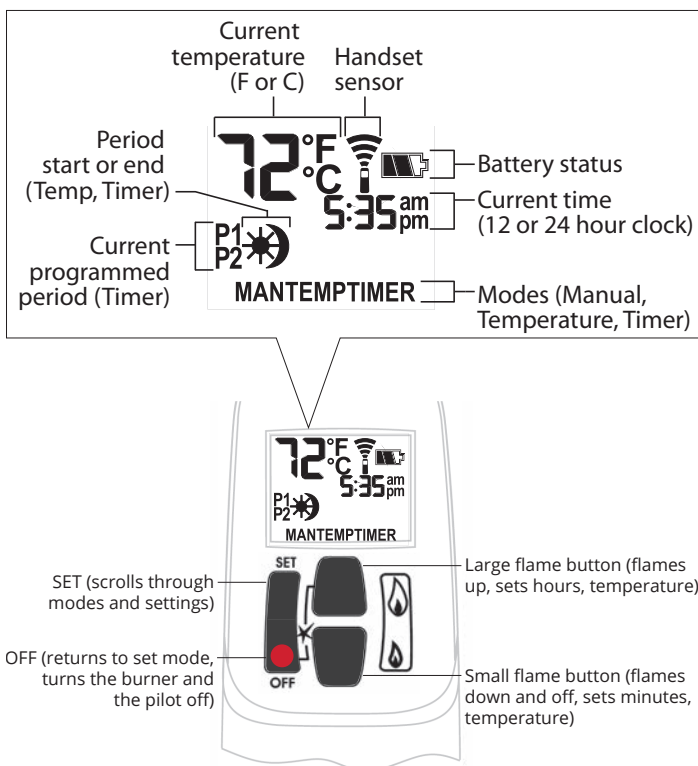

## Turn Fireplace ON

Press ● + 🔥 buttons until you hear a short beep; release buttons.

Beeping continues until pilot is lit.

Burner lights to maximum flame height and handset goes automatically to manual (MAN) mode.

NOTES:

On the valve, MAN button must be at ON, in full counter-clockwise position .

ON/OFF switch (if equipped) must be in I (ON) position.

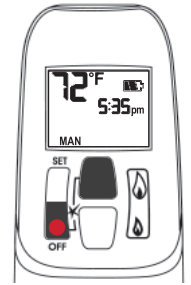

## Turn Fireplace OFF

Press ● button.

When pilot is just turned off, wait 2 minutes to light it again.

## Standby Mode (Pilot Flame)

Press and hold 🔥 to set fireplace to pilot.

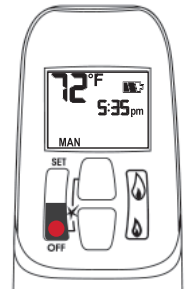

## Adjust Flames Height

With pilot lit, press and hold buttons:

🔥 = increase flame height

🔥 = decrease flame height or set to pilot

For fine adjustment, tap buttons.

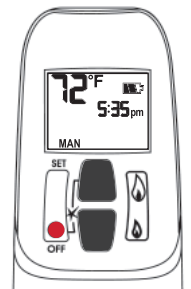

## Express Low and High Fire

Double-click buttons:

🔥 x 2 = increase flame to maximum height "HI"

🔥 x 2 = decrease flame minimum height "LO"

NOTE: Flame goes to high fire first before going to designated low fire.

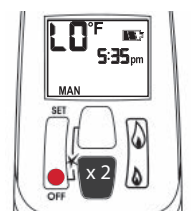
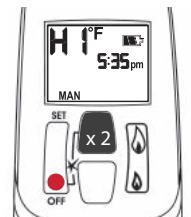

# Appendix B – Remote Control Operation

## Setting °C/24-hr or °F/12-hr clock

In MAN mode, press and hold ● + 🔥 buttons until temperature / clock display changes from

°F / 12-hour ↔ °C / 24-hour

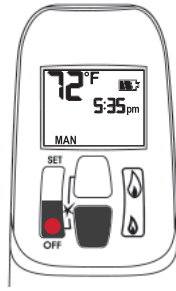

## Setting Time

The time display will flash after either:

- installing the battery, or
- pressing 🔥 + 🔥

To set the time, press buttons:

🔥 = hour

🔥 = minutes

Press ● or wait to go back to MAN.

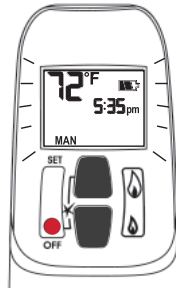

## Modes of Operation

Briefly pressing SET cycles through modes of operation.

MAN > ⚡TEMP > 🌙TEMP > TIMER > MAN

NOTE: Press 🔥 or 🔥 to reach MAN mode.

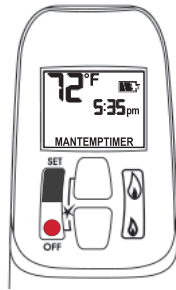

## MAN Manual Mode

Manual flame height adjustment.



## ⚡TEMP Daytime Temperature Mode

When pilot is lit, room temperature is measured and compared to set temperature. Flame height automatically adjusts to reach Daytime Set Temperature.



## 🌙TEMP Night time Setback Temperature Mode

When pilot is lit, room temperature is measured and compared to set temperature. Flame height automatically adjusts to reach Night Time Setback Temperature.

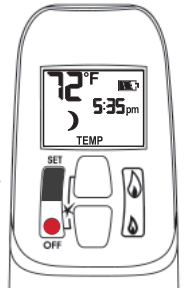

## TIMER Timer Mode

When pilot is lit, two periods of time (P1 and P2) can be programmed to use Daytime and Night time temperatures at specific times.

Note: Display shows set temperature every 30 seconds.



Set the different parameters when they are flashing.

# Appendix B – Remote Control Operation

## Setting high / low Temperatures

### Setting “DAYTIME” high temperature.

Default Settings: TEMP 23 °C/74 °F

Press SET to scroll to TEMP

Hold SET button until TEMP flashes.

To set Daytime Temperature:

= increases temperature.

= decreases temperature.

Press or wait to complete setting.

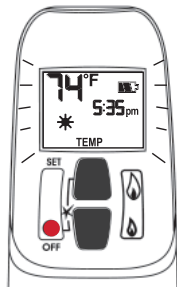

### Setting “NIGHT TIME SETBACK” low temperature.

Default Settings: TEMP “-” (OFF)

Press SET to scroll to TEMP

Hold SET button until TEMP flashes.

To set Night Time Temperature:

= increases temperature.

= decreases temperature.

Press or wait to complete setting.

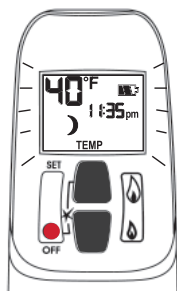

## Setting Program Timers

You can program two periods of time between 12 am and 11:50 pm in each 24-hour cycle.

Programs P1 and P2 must be set in the following order during a 24-hour cycle: **P1** , **P1** , **P2** and **P2** .

= Day Time temperature (high) program period

= Night Time temperature (low) program period

### Default Settings:

Program 1: **P1** 06:00 am **P1** 08:00 am

Program 2: **P2** 11:50 pm **P2** 11:50 pm

Press SET to scroll to .



If **P1** = **P1** or **P2** = **P2** , programming is cancelled.

To keep fireplace ON all night, set **P2** at 11:50 am and **P1** at 12:00 am.

If you want to program only one period, program **P1** and **P1** with desired times then **P2** and **P2** with the same time as **P1** .

### Setting P1 time—high temperature.

Hold SET button until **P1** is displayed and time flashes.

To set time:

= hour

= minutes

Press or wait to complete setting.

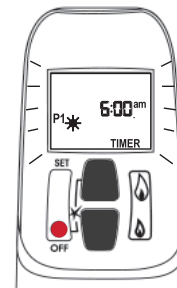

### Setting P1 time—low temperature.

Hold SET button until **P1** is displayed and time flashes.

To set time:

= hour

= minutes

Press or wait to complete setting.

# Appendix B – Remote Control Operation

## Setting P2 high and low temperature times.

Repeat same steps as Setting P1.

When all settings are complete, press ● to save them.

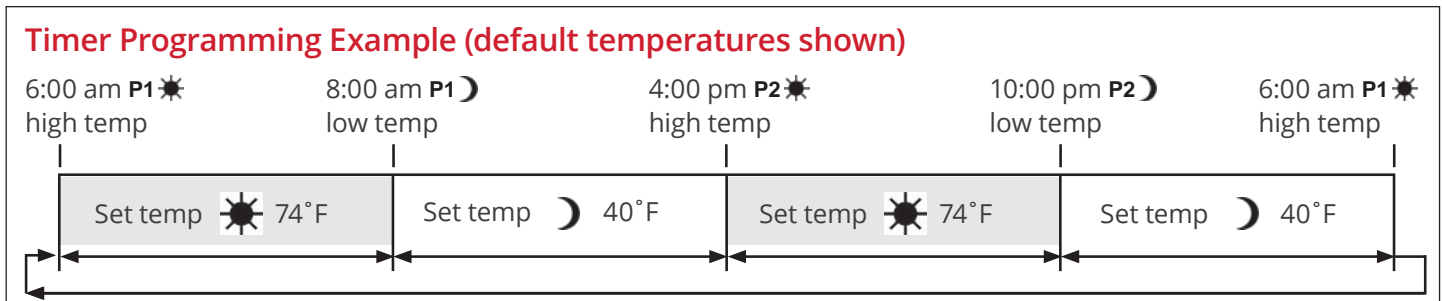

## Automatic Turn Down

### 8-Hour no Motor Movement

The valve will turn to pilot flame if there is no motor movement for an 8-hour period.

## Automatic Shut-Off

**Low Batteries Receiver.** With low battery power in the battery holder the system shuts off the fire completely. This does not apply when the power supply is interrupted.

**On-Demand Pilot (7 Day Shut-Off).** This green feature eliminates gas energy consumption during extended appliance inactivity. When the appliance is inactive for an extended period of time the system automatically extinguishes the pilot. This feature helps the consumer realize cost benefits by automatically eliminating energy consumption during non-heating months and limited use.

The programmed length of inactivity to activate the system is specified by the appliance manufacturer and cannot be altered in the field.

## Low Battery Indication

### ! Caution

**DO NOT USE** a screwdriver or other metallic object to remove batteries from holder. This could cause a short-circuit.

**Handset:** The battery icon  will show when the battery needs to be replaced. Replace with one 9 V **alkaline** battery.

**Battery holder:** Frequent 'beeps' for 3 seconds when the valve motor turns indicate the batteries need to be replaced in battery holder. Replace with four 1.5 V **alkaline** batteries.

## Handset / Receiver Match

The remote control handset and receiver are programmed to function together. In case of a replacement of the handset or the receiver, you will need to reset the receiver to allow them to function together. Contact your dealer for details.



# Appendix C – Spare Parts

	Description	Part no.
1	Side wall support (2)	330A898
2	Rear wall support	320B320
3	Velcro strip	4000022
4	Port cover	4000828AH
5	Exhaust slide assembly	4005299
6	Exhaust slide gasket	4001662
7	2.5–4.5" hose clamps (2)	4000768
8	Restrictor plates (2)	4002895
9	Adjustable plates (2)	4002896
10	Window unit	050A216
11	Window screw assy (2)	000B214S
12	Hot glass warning plate	4003093
13	Burner module (natural gas)	4001722
	Burner module (propane gas)	4001723
14	Burner unit incl. #22 (natural gas)	3000025
	Burner unit incl. #22 (propane gas)	740K185
15	Aeration shutter slider (natural gas)	4002345
16	Aeration shutter cover (natural gas)	4002346
17	Aeration shutter slider (propane gas)	320B293
18	Flashback shield (propane gas)	3000371
19	Pilot unit complete (natural gas)	4000062
	Pilot unit complete (propane gas)	4000063
20	Pilot injector (natural gas)	4002511
	Pilot injector (propane gas)	720A195
21	Thermocouple	4000061
22	Hooked olive for pilot	720A196
23	Electrode	720A543
24	Electrode nut	720A200
25	Olive nut for pilot	420K385
26	Pilot shield	4000144
27	Pilot support bracket	330A904
28	Main burner pipe	030A225
29	Olive nut	220K567
30	Olive	420K342
31	Base support bracket (2)	330A894
32	Spacer angle (2)	4000355
33	Elbow injector (natural gas)	720A580
	Elbow injector (propane gas)	9730013
34	Pilot pipe	030A226
35	Snap off olive nut	220K913
36	Window support	320B399
37	Switch bracket	4001070
38	Switch with cable	4001036
39	Cable interrupter/receiver	4001035
40	Interrupter block	4001037
41	GV60 Valve (natural gas)	4003094
	GV60 Valve (propane gas)	4003107
42	Ignition cable	4001039
43	Ignition cable sleeve	4002244

	Description	Part no.
44	Receiver G6R-R3AM-ZV (CP)	4001911
45	Wiring harness	4001187
46	Handset G6R H3T5-ZV (BJ)	4001910
47	Wall mount holder	9000008
48	Auxiliary battery holder	4006553
49	Battery holder cable 1500 mm	4006552
50	GV60 Valve repair kit (not included)	4004544
51	Ceramic coals & liners set	530CSK
52	Ceramic coal set	000B245
53	Centre left coal	640K615
54	Base coal	650K237
55	Centre right coal	640K616
56	Front right coal	640K618
57	Front left coal	640K617
58	Ceramic reversible walls set	4001160
59	Rear reversible panel	4001161
60	LH reversible panel	4001162
61	RH reversible panel	4001163
62	Traditional logs & liners set	530LSK
63	Traditional log set	4000162
64	Right middle log	4000372
65	Right side front log	4000470
66	Front log	4000370
67	Base log	4000368
68	Left middle side log	4000371
69	Rear log	4000369
70	Ceramic reversible walls set	4001160
71	Rear reversible panel	4001161
72	LH reversible panel	4001162
73	RH reversible panel	4001163
74	Ceramic rocks & liners set	530RSK
75	Top far left rock	4001867
76	Top left rock	4001868
77	Top right rock	4001869
78	Top far right rock	4001870
79	Left rock	4001877
80	Right rock	4001878
81	Bottom left rock	4001874
82	Bottom center rock	4001875
83	Bottom right rock	4001876
84	Middle left rock	4001871
85	Middle center rock	4001872
86	Middle right rock	4001873
87	Rock base	4001880
88	LH reversible wall	4001162
89	Rear fluted wall	4001881
90	RH reversible wall	4001163
91	Rock base support	4001882AH
92	Ceramic platform	4001879



# Appendix C – Spare Parts

	Description	Part no.
93	Driftwood Kit	530DWK
94	Log Set (including pebbles)	4005603
95	Base log	4005887
96	Rear log	4005888
97	Left log	4005889
98	Right log	4005890
99	Centre log	4005891
100	Brown beach pebble	4003082
101	Small grey beach pebble	4003086
102	Grey beach pebble	4003083
103	Small beige beach pebble	4003087
104	Metal platform	4006017AH
105	Rear liner panel fluted	4001881
106	Reversible LH brick/fluted panel	4001162
107	Reversible RH brick/fluted panel	4001163
108	Rear liner holder support	4001882AH

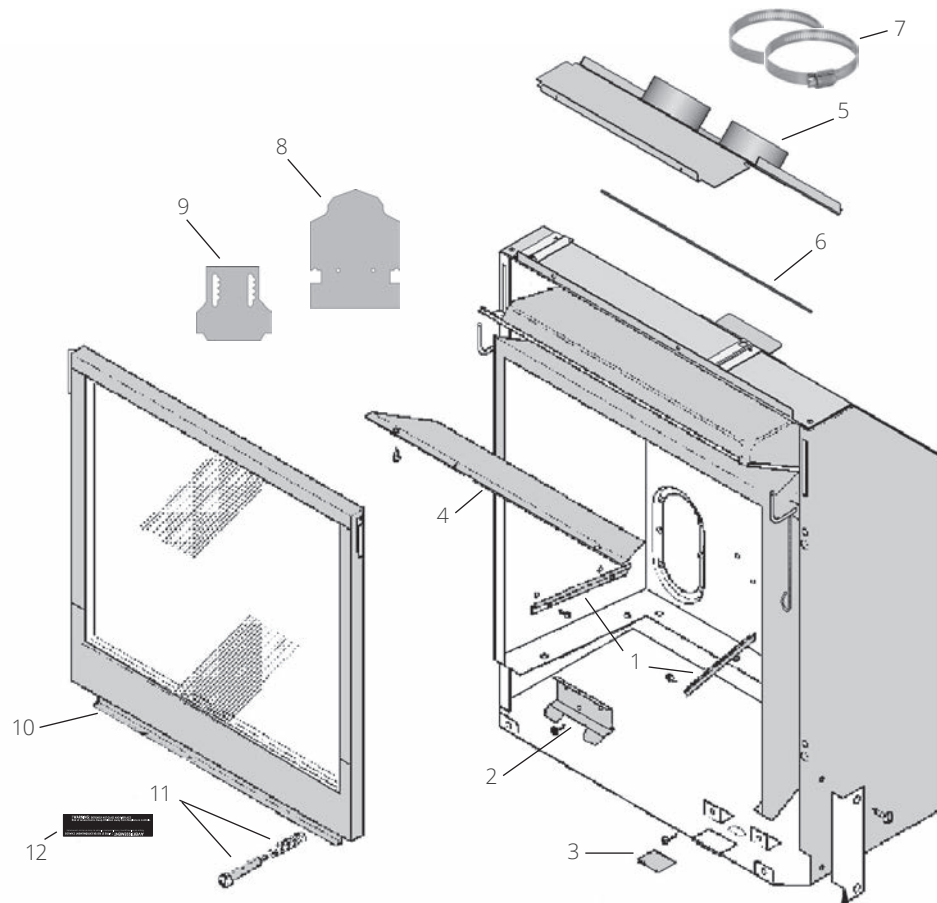

# Appendix C – Spare Parts

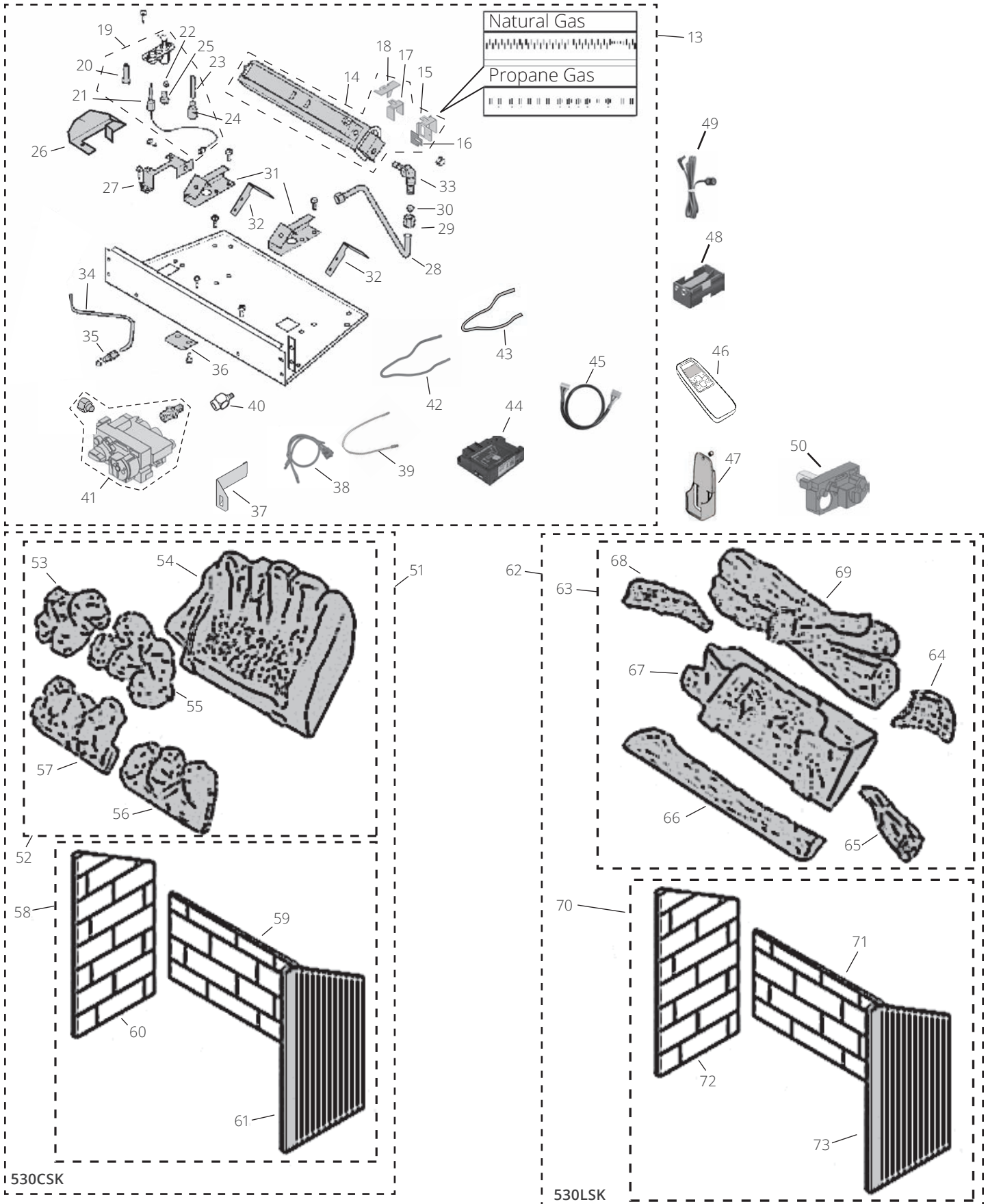

# Appendix C – Spare Parts

