

Installation Manual



PORTRAIT

Direct Vent Zero Clearance
Gas Fireplace
natural gas 530IN
propane gas 530IP

Installer: Place model/serial number here.

Installer: Leave this manual with the appliance.
Consumer: Retain this manual for future reference.

⚠ WARNING:
FIRE OR EXPLOSION HAZARD

Failure to follow safety warnings exactly could result in serious injury, death, or property damage.

Do not store or use gasoline or other flammable vapors and liquids in the vicinity of this or any other appliance.

WHAT TO DO IF YOU SMELL GAS

- Do not try to light any appliance.

- Do not touch any electrical switch; do not use any phone in your building.
- Leave the building immediately.
- Immediately call your gas supplier from a neighbor's phone. Follow the gas supplier's instructions.
- If you cannot reach your gas supplier, call the fire department.

Installation and service must be performed by a qualified installer, service agency or the gas supplier.

⚠ DANGER



Hot glass will cause burns.

Do not touch glass until cooled.

Never allow children to touch glass.

A barrier designed to reduce the risk of burns from the hot viewing glass is provided with this appliance and must be installed for the protection of children and other at-risk individuals.

This appliance may be installed in an after-market permanently located, manufactured (mobile) home where not prohibited by local codes. This appliance is only for use with the type of gas indicated on the rating plate. This appliance is not convertible for use with other gases, unless a certified kit is used.

INSTALLER: Leave this manual with the appliance.
CONSUMER: Retain this manual for future reference.

Massachusetts:

The piping and final gas connection must be performed by a licensed plumber or gas fitter in the State of Massachusetts. Also, see Carbon Monoxide Detector requirements in this manual.

⚠ WARNING

This product can expose you to chemicals including Benzene, which is known to the State of California to cause cancer and birth defects or other reproductive harm. For more information go to www.P65Warnings.ca.gov.

Note: Natural gas, in its original state, contains Benzene.

This manual contains instructions to install the **ENGINE ONLY**. A trim kit is **REQUIRED** to complete the installation. A barrier screen is provided with the trim kit. **Refer to the manual supplied with the trim for installation.**

This appliance is a domestic room-heating appliance. It must not be used for any other purposes such as drying clothes, etc.

This appliance is suitable for installation in a bedroom or bed sitting room.

Ce guide est disponible en français sur demande.



We recommend a US Certified National Fireplace Institute (NFI) specialist install our gas hearth products.



The information contained in this manual is believed to be correct at the time of printing. Miles Industries Ltd. reserves the right to change or modify any information or specifications without notice. Miles Industries Ltd. grants no warranty, implied or stated, for the installation or maintenance of your heater, and assumes no responsibility for any consequential damage(s).

© Copyright Miles Industries Ltd., 2022. All rights reserved.
Designed and manufactured for Miles Industries Ltd.

Welcome to Valor®

This appliance has been professionally installed by:

Dealer Name: _____

Phone: _____

Fireplace Safety	4
Specifications	6
Kits & Accessories	8
Dimensions & Clearances	8
Framing	9
Wall Finish	9
Venting	10
Overview	10
Co-Axial	11
Typical Co-Axial Venting Components.....	11
Rear Vent—No Vertical Rise	12
Horizontal Vent Termination Location.....	13
Venting Configurations—With Vertical Rise	14
Venting Charts	15
Co-Axial Vertical Installations	16
Restrictors.....	17
Co-Linear Conversion.....	18
Co-Linear Vent Installations	18
Co-Linear Venting Components	19
Preparation	20
Before Installing.....	20
Window & Burner Removal	21
Vent Outlet.....	22

Please read this manual BEFORE installing and operating this appliance.

Installation	24
Gas Supply.....	24
Liner Panels—Traditional Logs & Coals.....	25
Fuel Beds	26
Traditional Logs Set 530LSK	26
Coal Set 530CSK.....	27
Rock Set and Liners 530RSK.....	28
Driftwood Kit and Liners 530DWK.....	30
Refit & Check Window.....	32
Battery Holder.....	33
Remote Control Pairing.....	34
Burner aeration.....	35
Accessories	36
Front and Barrier Screen	36
Handset Wall Holder.....	36
Wiring Diagram	37
Approved Venting Components	38
Commonwealth of Massachusetts	40
Appendix A – Lighting Instructions Plate	42
Appendix B – Remote Control Operation	43
Appendix C – Spare Parts	47

Fireplace Safety

This manual contains very important information about the safe installation and operation of the fireplace. Read and understand all instructions carefully before installing and operating the fireplace. Failure to follow these instructions may result in possible fire hazard and will void the warranty.

Replacement manuals are available by contacting the Valor Customer Service at 1-800-468-2567, or by visiting valorfireplaces.com.

WARNING: Extremely Hot!

Heat and flammability

- Some parts of the fireplace are extremely hot, particularly the glass window. Use the barrier screen provided with the trim or a gate to reduce the risk of severe burns.
- The glass windows can exceed 500°F at full capacity.
- Always keep the appliance clear and free from combustible materials, gasoline, and other flammable vapors and liquids.
- Be aware of hot wall surfaces! The wall directly above the fireplace can get very hot when the fireplace heats. Although safe, it may reach temperatures in excess of 200° F depending on choice of trims or optional accessories. Do not touch!
- Be aware of hot hearth/floor surfaces! The hearth or floor directly in front of the fireplace can get very hot when the fireplace heats. Although safe, they may reach temperatures in excess of 200° F depending on elevation of hearth. Do not step on it! Temperature of hearth/floor surface will be reduced when barrier screen is installed.
- Solid wood flooring in front of the fireplace (if allowed) may shrink during the heating season due to heat.
- Some materials or items, although safe, may discolor, shrink, warp, crack, peel, and so on because of the heat produced by the fireplace. Avoid placing candles, paintings, photos and other combustible objects sensitive to heat or furniture within 36 inches (0.9 m) around the fireplace.
- Due to its high temperature, the appliance should be located out of traffic areas and away from furniture and draperies.

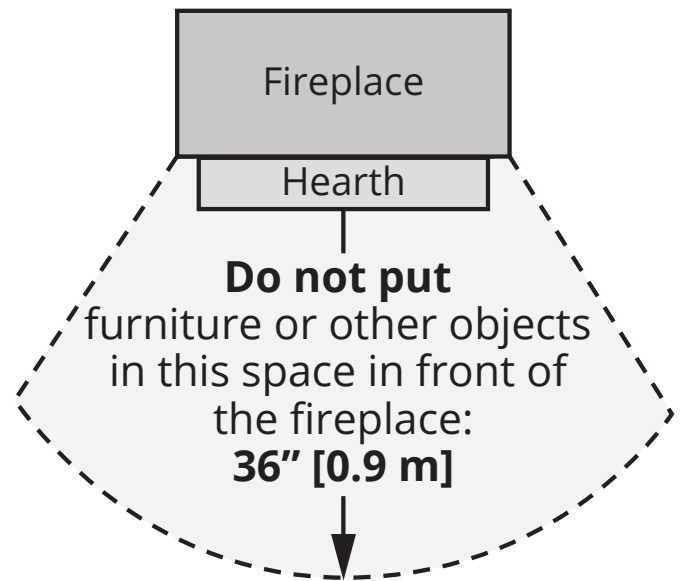

Barrier Screen and Safety

- Any safety screen, guard, or barrier removed for servicing an appliance must be replaced prior to operating the appliance
- Children and adults should be alerted to the hazards of high surface temperature and should stay away to avoid burns or clothing ignition.
- Young children should be carefully supervised when they are in the same room as the appliance. Toddlers, young children, and others may be susceptible to accidental contact burns. A physical barrier is recommended if there are at-risk individuals in the house. To restrict access to a fireplace or stove, install an adjustable safety gate to keep toddlers, young children, and other at-risk individuals out of the room and away from hot surfaces.
- A barrier designed to reduce the risk of burns from the hot viewing glass is provided with this appliance and shall be installed for the protection of children and other at-risk individuals.

Fireplace Safety

- Clothing or flammable material should not be placed on or near the appliance.

Glass window



WARNING

Do not operate this appliance with the glass front removed, cracked, or broken. Replacement of the glass front should be performed by a licensed or qualified service person. Do not strike or slam the glass front.

- The glass front assembly must be in place and sealed before the unit can be placed into safe operation.
- The glass front assembly must only be replaced as a complete unit, as supplied by the fireplace manufacturer. No substitute material may be used.
- Do not use abrasive cleaners on the glass front assembly. Do not attempt to clean the glass front when it is hot.

Venting

- This unit must be used with a vent system as described in this manual. No other vent system or components may be used.
- Never obstruct the flow of combustion and ventilation air. Keep the front of the appliance clear of all obstacles and materials for servicing and proper operation.
- This gas fireplace and vent assembly must be vented directly to the outside and must never be attached to a chimney serving a separate solid fuel burning appliance. Each gas appliance must use a separate vent system. Common vent systems are prohibited.

Intended use

- This appliance is designed and approved as a supplemental heater and provides the potential for most energy conservation when used while attended. The use of an alternate primary heat source is advisable.
- This unit is not for use with solid fuel.
- Do not use this heater as a temporary source of heat during construction.

Installation and Servicing

- Installation and repair should be done by a qualified service person. The appliance should be inspected before use and at least annually by a professional service person. More frequent cleaning might be required due to excessive lint from carpeting, bedding material, et cetera. It is imperative that control compartments, burners, and circulating air passageways of the appliance be kept clean.
- Do not use this appliance if any part has been under water. Immediately call a qualified service technician to inspect the appliance and to replace any part of the control system and any gas control that has been under water.

Specifications

Approval & Codes

This appliance is certified to ANSI Z21.88/CSA 2.33 American National Standard / CSA Standard for Vented Gas Fireplace Heaters for use in Canada and USA, and to CGA 2.17-M91 High Altitude Standard in Canada. This appliance is for direct vent installations.

This appliance complies with CSA P.4.1-15 Testing method for measuring annual fireplace efficiencies.

The installation must conform to local codes or, in the absence of local codes, with the National Fuel Gas Code, ANSI Z223.1/NFPA 54 or the Natural Gas and Propane Installation Code CAN/CGA-B149.1. Only qualified licensed or trained personnel should install this appliance.

This appliance must be electrically grounded in accordance with local codes, or, in the absence of local codes, with the National Electrical Code, ANSI/NFPA 70 or the Canadian Electrical Code, CSA C22.1.

Ratings

Model	530IN	530IP
Gas	Natural	Propane
Altitude (Ft.)*	0-4,500 feet*	
Input Maximum (Btu/h)	20,500	19,000
Input Minimum (Btu/h)	6,500	12,500
Manifold Pressure (in w.c.)	3.5-3.9"	10.3-10.7"
Minimum Supply Pressure (in w.c.)	5"	11"
Maximum Supply Pressure (in w.c.)	10.5"	14"
Main Burner Injector Marking	580	200
Pilot Injector Marking	35	27
Min. Rate By-Pass Screw	125	125

*High Altitude Installations

Input ratings are shown in BTU per hour and are certified without deration for elevations up to 4,500 feet (1,370 m) above sea level.

For elevations above 4,500 feet (1,370 m) in USA, installations must be in accordance with the current ANSI Z223.1 and/or local codes having jurisdiction. Heating value of gas in some areas is reduced to compensate for elevation—consult your local gas utility to confirm.

For installations at elevations above 4,500 feet (1,370 m) in Canada, please consult provincial and/or local authorities having jurisdiction.

Supply Gas

Heater engine 530IN is used with natural gas.

Heater engine 530IP is used with propane gas.

The supply pressure must be between the limits shown in the Ratings table.

The supply connection is 3/8" NPT female located at the left side of the control valve. The opening for the gas supply line is at the rear left corner of the appliance.

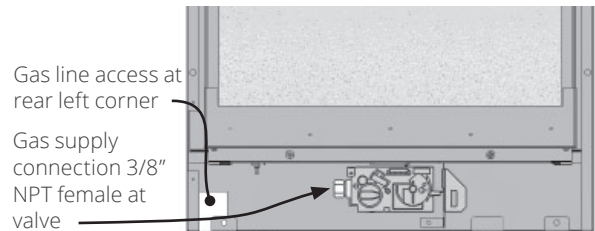

Gas Conversion

The 530 fireplace is offered with natural gas or propane gas. It can be converted from one gas to the other. See installation manual supplied with the gas conversion kit for more information.

Fuel Beds

The 530 engine can use a simulated logs, coals, rocks or driftwood fuel bed with natural gas or propane.

Electrical

The 530 does not require an electrical power source unless fitted with an optional circulating fan.

WARNING

Optional electrical accessories ARE NOT ALLOWED when adapting appliance for outdoor use.

Specifications

Floor/Hearth

This appliance is approved for installation directly on combustible material such as plywood and so on. Vinyl, carpet, and soft flooring require sheet metal extending the whole width and depth under the appliance. This appliance does not require a hearth. Combustible flooring may extend up to the front of the unit.

Front Trims/Stove

Various fronts are available for the 530 engine. This engine may be installed as a free standing, zero clearance or insert application depending on which style front trim is selected. **The front trim/stove style affects the framing cavity. A front trim kit is required for all applications and should be on site when the engine is installed** as the parts to make the engine suitable for zero clearance are supplied with the front trim kits (except 549 front).

Outdoor Conversion Kit

The 530 model is supplied standard for indoor applications and may be adapted for installation in specific "outdoor" applications protected from weather as defined in the GV60CKO Outdoor Conversion Kit manual.

Kits & Accessories

Required Kits

Fuel Beds (choose one)		
530LSK	Traditional Logs & Reversible Liners Set	
530RSK	Rocks & Reversible Liners Set	
530CSK	Coals & Reversible Liners Set	
530DWK	Driftwood & Reversible Liners Set	
Fronts/Stove (choose one)		Barrier Screen
Zero Clearance Installations		
536CXB	President ZC Front	4006382
539/550	Windsor and Classic Arches	4003290
541BPC	Bolero Front	4003289
545CFVZC	Clearview ZC Front	4005146
563CSB	Senator Front	4003291
569LFB	Ledge Front	4003375
Insert Installations		
536CXBI	President Insert Front (closure plate 582 or 583 required)	4006382
545CFV	Clearview Insert Front (closure plate 582 optional)	4005146
546LF	Ledgeview Insert Fronts	4005099
539/549/550	Windsor and Classic Arches	4003290
Free Standing Stove Installations		
531CSB	President Stove FS	4006382

Optional Accessories

Gas Conversion Kits	
530NGK	Conversion to natural gas
530PGK	Conversion to propane gas
Other Accessories	
GV60CKO	Outdoor Fireplace Conversion Kit
582CPB	Closure Plate, black, 26" w x 31" h (use with 536CXBI or 545CFV)
583CPB	Closure Plate, black, 30" w x 33" h (use with 536CXBI)
567FGP	Top Grille (DO NOT USE with coals)
580RGL	Reflective Glass Liners (installs on top of liners supplied with fuel bed)
556CLA	Co-Linear Adapter
555CFK	Circulating Fan Kit
1265WSK	Wall Switch Kit
RBWSK	Remote Battery & Wall Switch Kit
GV60PAK	AC Adapter
Hearth Gate	Hearth gates such as Cardinal's VersaGates are available at retail stores carrying safety products for children.

Information accurate at the time of printing and subject to change without notice.

Dimensions & Clearances

The dimensions and clearances vary with each application and with the front trim installed. Refer to the installation instructions of the front trim chosen for more information.

WARNING

Some materials or items, although safe, may discolor, shrink, warp, crack, peel, and so on because of the heat produced by the fireplace. Avoid placing candles, paintings, photos, and other items sensitive to heat around the fireplace.

WARNING

HOT HEARTH/FLOOR! The hearth or floor in front of the fireplace may become very hot when the fireplace heats. Do not use the hearth as a seat or shelf. Solid wood flooring in front of the fireplace (if allowed) may shrink during the heating season due to heat.

The framing vary with each application and with the front trim installed. Refer to the installation instructions of the front trim chosen for more information.

Planning Wall Finish

Non-Combustible Materials Specifications

Non-combustible materials will not ignite and burn. Such materials are those consisting entirely of steel, iron, brick, tile, concrete, slate, glass or plasters, or any combination thereof.

Materials that are reported as passing ASTM E 136, Standard Test Method for Behavior of Materials in a Vertical Tube Furnace at 750 °C shall be considered non-combustible materials.

Combustible Materials Specifications

Materials made of or surfaced with wood, compressed paper, plant fibers, plastics, or other material that can ignite and burn, whether flame proofed or not, or plastered or unplastered shall be considered combustible materials.

Non-combustible cement board—ZC applications

With most front trims, the 530 fireplace installed in a zero clearance application will require a ½" [13 mm] thick non-combustible cement board or equivalent, to be used as a wall surface immediately above the unit—see front trim installation manual for more information.

Extending the cement board well beyond the minimum shown will help avoid cracking due to differential expansion of materials. Pre-drill cement board with oversized holes and do not over-tighten screws to avoid cracking due to heat expansion.

Standard gypsum wall board may be used beyond the perimeter of the cement board although it is preferable not to change materials to help avoid cracking.

Finishing around trims

Additional non-combustible material such as tile and others may be applied over top of the wall surface or you may choose to leave it finished clean with no tile.

Be aware that a trim is always required and that the wall finish thickness must be taken into account for all installations.

Avoiding Cracking Wall Finishes

If a clean finish with no tile, etc. is desired, joints in the non-combustible board and the transition to gypsum board will require special attention if future cracking is to be controlled.

Shrinkage and differential movement of the framing and non-combustible wall board can transmit cracking through to tiles, etc.

Be aware that temperatures on the non-combustible wall surface above the appliance can exceed 185°F.

Below are some tips on how to best avoid any cracking:

- Allow materials to dry thoroughly before finishing the wall. Cement board has the ability to absorb up to 30 percent of its weight in water and may shrink as much as 1/8" over a 48" length when drying from a saturated condition. Running the fireplace for an extended period before final finishing will help drive out moisture.
- Always pre-drill screw holes through cement board and use screws with self-milling head.
- Always use mesh tape over joints.
- Always stagger joints in wall board.
- Behind joints, double up studs or use studs "on the flat" to add extra support to the joint. Adhesive on the backside of wall board behind any joints can help control differential movement.
- Use multiple, thinner coats of joint compound and allow to dry thoroughly between coats.
- Ensure framing materials are dry.
- After finishing the wall, introduce heat gradually to slowly dry any excess moisture rather than drying too fast.
- Avoid notching cement board or tiles around corners of window opening and instead provide a joint that intersects the corner.
- Avoid using large, one-piece slab of material with a cut-out in the middle as a surround for the fireplace. Expansion above the opening will cause cracking at inside corners. Provide a joint that intersects the inside corner to avoid cracking.

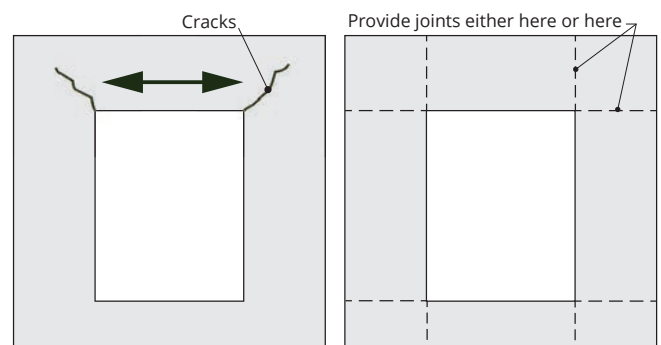

Top or Rear Facing Outlet

The 530 appliance is supplied standard with a rear facing direct vent outlet and may be converted to a top facing direct vent outlet with no extra parts required—see .

The 530 appliance is supplied with a smooth 4 x 6-5/8" co-axial collar and will require a 817VAK Vent Adapter to convert the collar to a twist-lock type collar.

Vent Material

This appliance is approved for installation using 4 x 6-5/8-inch co-axial direct vent pipe and accessories as listed in *Approved Venting Components* pages 38–39.

This appliance may also be converted to co-linear venting with two 3-inch pipes for use in solid-fuel burning fireplaces and chimneys using approved adapters and accessories. See *Co-Linear Conversion* pages 18–19 and *Approved Venting Components* pages 38–39.

Follow the installation instructions supplied with the individual venting accessories.

Do not mix components from different manufacturers.

Do not cut pipe lengths; use adjustable lengths instead.

Vent Sealing

Seal all outer co-axial pipe and elbow joints, including sectioned elbow joints, using high quality, high temperature 2-inch wide self-adhesive aluminum foil tape (Nashua-322-2 brand or similar). Wrap the tape completely around all joints and press firmly to seal.

A high-temperature black silicone sealant may be used in the outer joints as a substitute to foil tape.

Ensure all the pipe joints have a minimum of 1-1/4 inch overlap.

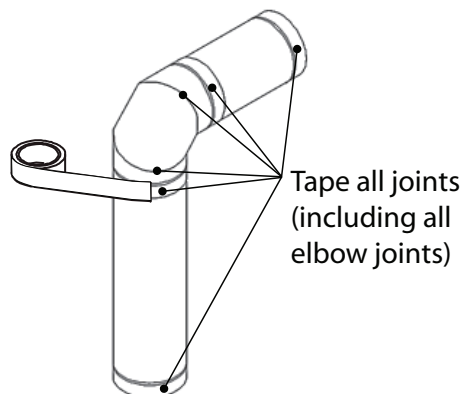

Wall Thickness

The appliance vent is suitable for penetrating a combustible wall assembly up to 14 inches in thickness. A non-combustible wall can be of any thickness up to the maximum horizontal run of vent pipe allowed for the particular installation.

Vent Penetration Through Walls & Ceilings

Combustible

When penetrating through combustible walls and ceilings, frame a minimum of 10 inches x 10 inches opening and ensure that the insulation is kept clear of the vent pipe using either a wall thimble or an attic insulation shield. Follow the installation instructions supplied with the individual venting components.

Non-combustible

If the wall is totally non-combustible (e.g. masonry block or concrete), mark for a 7-inch circular hole.

In both cases, the center of the hole should line up with the center line of the horizontal vent.

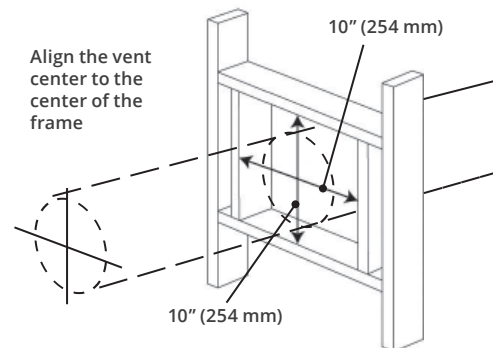

All horizontal pipe runs must be graded 1/4 inch per foot upwards in the direction of the exhaust flow. The final pipe length, when terminating through the wall may be graded downwards slightly to prevent water migration.

Co-Linear Direct Vent Installations for Free Standing or Recessed Installations (flexible piping)

Converts the appliance outlet collars to accept two 3-inch diameter flexible liners for installation into existing solid-fuel burning fireplaces and chimneys. Requires a co-linear adapter at the appliance and either a co-linear terminal or co-linear-to-co-axial terminal at the top of the chimney. Sidewall co-linear installation is also possible using a 720WSK Sidewall Termination Kit—see instructions packed with the kit. A list of approved venting accessories is shown on

Venting

Co-Axial

Typical Co-Axial Venting Components

See venting accessories list on page 10 for allowable components.

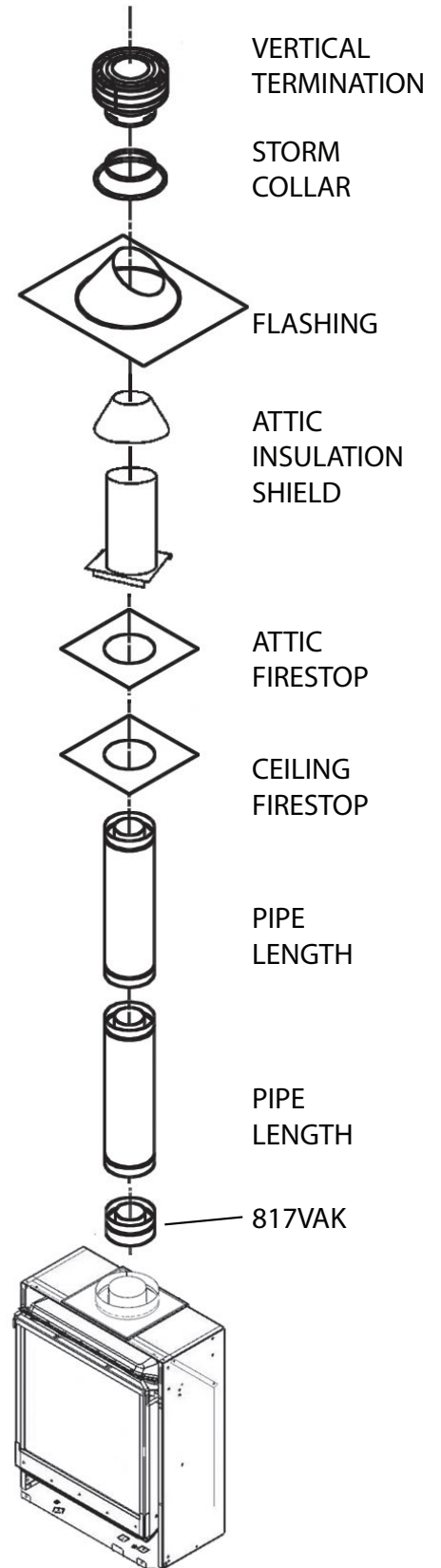
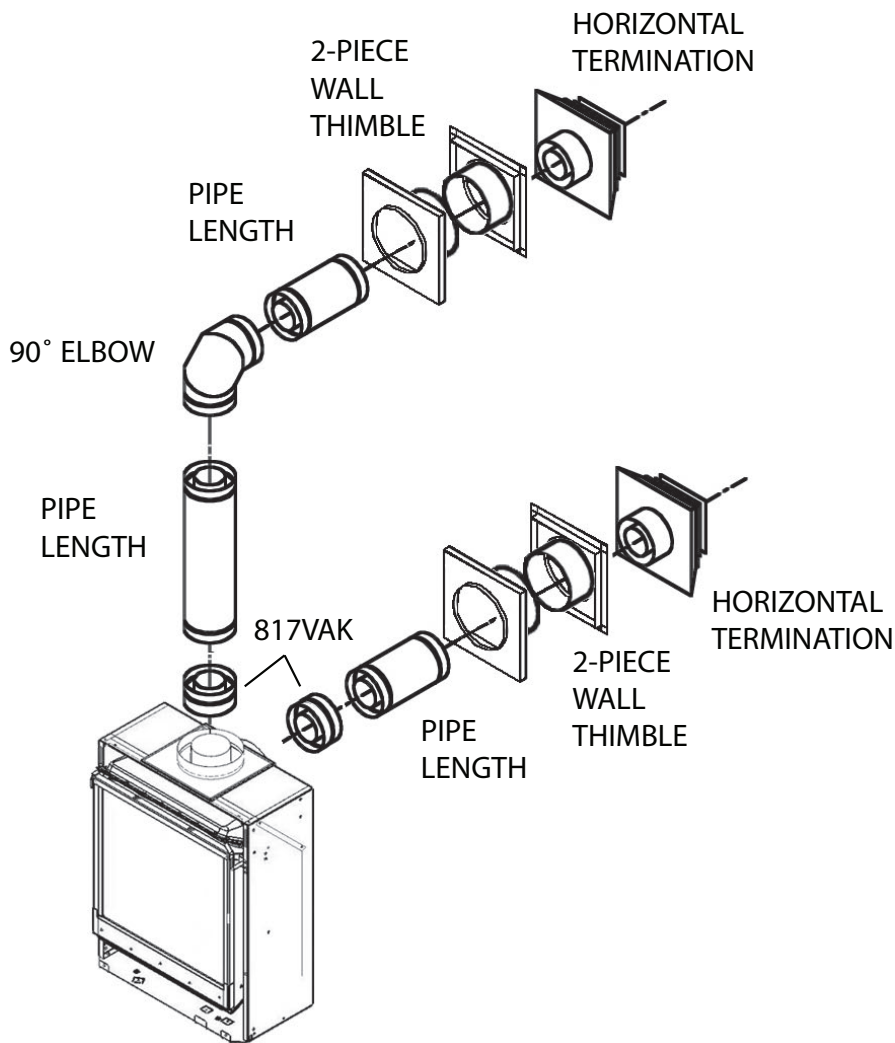

Rear Vent—No Vertical Rise

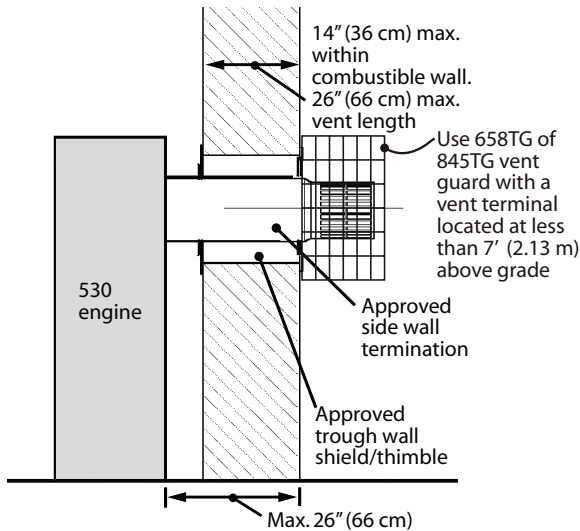

Rear vent—no vertical rise

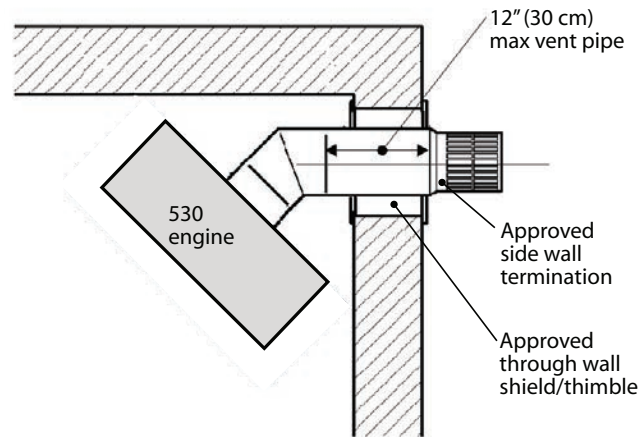

Corner rear vent—no vertical rise

Important Installer Notice—Weather Sealing & Vapor Barrier

It is the installer's responsibility to ensure that vent installations through exterior walls are caulked and weatherproofed in such a manner as to:

- Prevent rain from entering the wall from the weather side by adequately caulking the outer vent plate to the exterior wall surface.
- Prevent moisture inside the home from penetrating into the wall structure by ensuring the inside wall plate is adequately sealed to the inside vapor barrier.
- Prevent rain water and moisture from entering the walls by sealing the joints between the outer vent tube and the inner and outer wall plates.

We recommend the use of a high quality polyurethane sealant.

Horizontal Vent Termination Location

- The vent terminal must be located on an outside wall or through the roof.
- This direct vent appliance is designed to operate when an undisturbed airflow hits the outside vent terminal from any direction.
- The minimum clearances from this terminal that must be maintained when located on an outside wall are shown in figure below. Any reduction in these clearances could result in a disruption of the

airflow or a safety hazard. Local codes or regulations may require greater clearances.

- The vent terminal must not be recessed into a wall or siding.
- The vent terminal should be positioned where any snowdrifts will not cover it.
- Sidewall vent terminations require a terminal guard such as 658TG or 845TG when accessible—within 7' of ground.

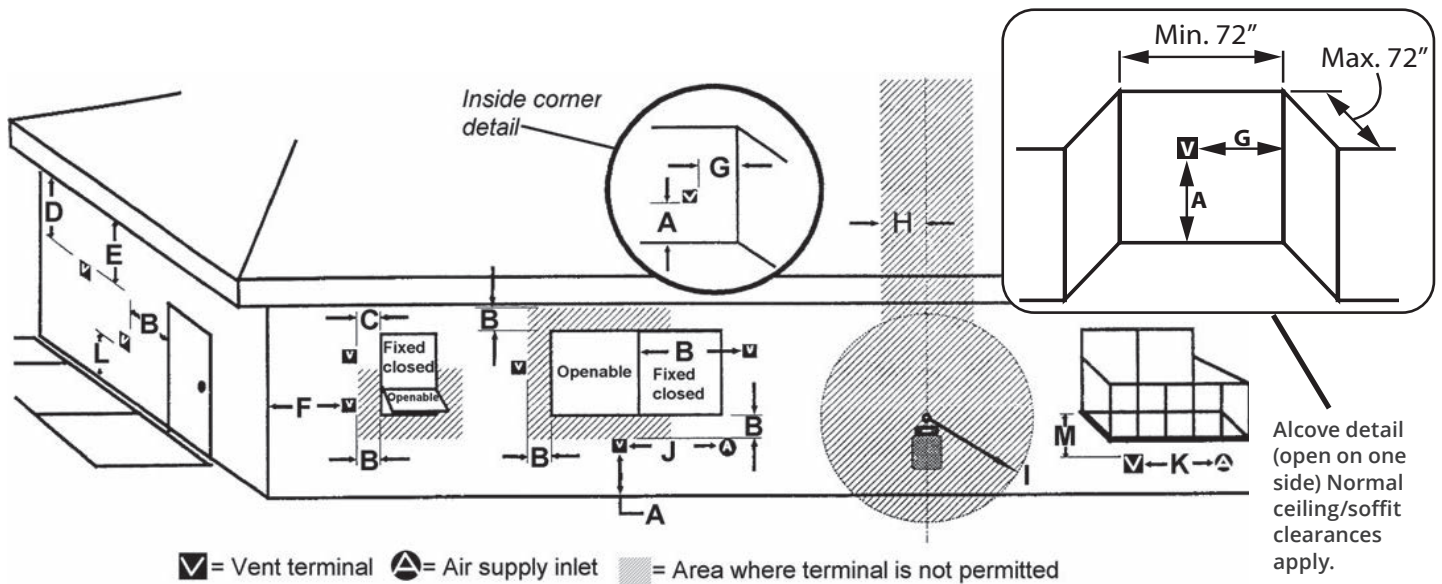

KEY	VENT TERMINAL LOCATIONS - MINIMUM DISTANCES	MINIMUM CLEARANCE	
		Inches	Cm
A	Clearance above grade, verandah, porch, deck or balcony	12	30
B	Clearance to window or door that may be opened	12	30
C	Clearance to permanently closed window (recommended to prevent condensation on window)	12	30
D	Vertical clearance to ventilated soffit located above the terminal within a horizontal distance of 2 feet (60 cm) from the center-line of the terminal	18	46
E	Clearance to unventilated soffit	12	30
F	Clearance to outside corner (measured from the center of vent)	12	30
G	Clearance to inside corner (measured from the center of vent)	12	30
H	Horizontal clearance to center-line of meter/regulator assembly located within 15 feet (4.6 m) below the terminal	36	90
I	Clearance to service regulator vent outlet	36	90
J	Clearance to non-mechanical air supply inlet to the building or the combustion air inlet to any other appliance	12	30
K	Clearance to a mechanical air supply inlet	72	180
L	Clearance above paved sidewalk or a paved driveway located on public property Note: A vent must not terminate directly above a sidewalk or paved driveway, which is located between two single-family dwellings and serves both dwellings. THIS DOES NOT APPLY to direct vent, non-condensing appliances in the Province of Ontario.	84	210
M	Clearance under a verandah, porch, deck or balcony Only permitted if veranda, porch, deck or balcony is fully open on a minimum of 2 sides beneath the floor	12	30

Note: Local codes and regulations may require different clearances.

Venting

Co-Axial

Venting Configurations—With Vertical Rise

4 x 90° ELBOWS MAXIMUM
(or equivalent)

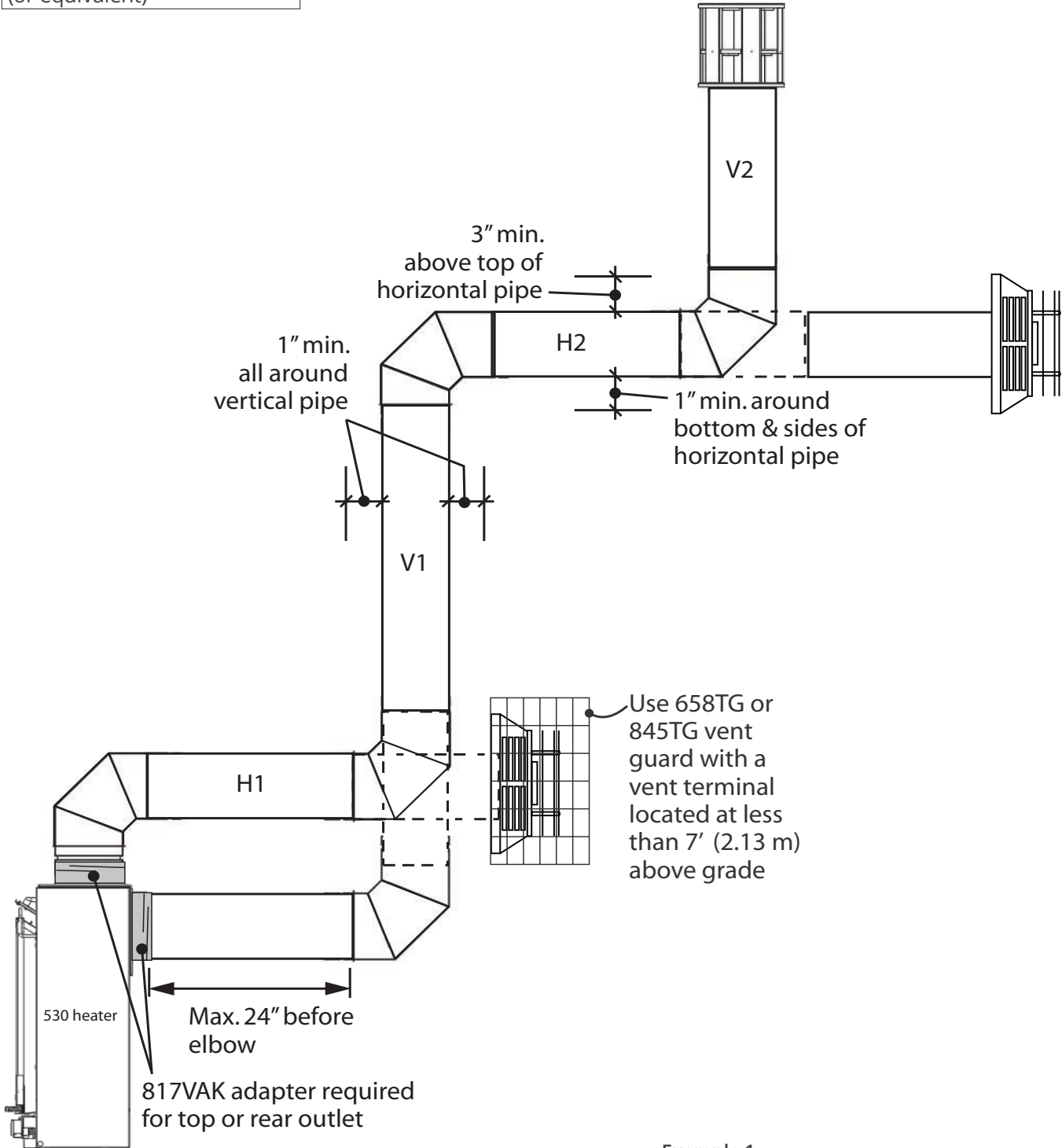

Example 1
Value V = V1 (6') + V2 (4') = 10'
Value H = H1 (2') + H2 (1') = 3'

How to Read the Venting Charts

The charts below apply to co-axial roof or wall termination in installations with vertical rise. See page 17 for installations with no vertical rise.

1. The total length of the vent pipe cannot exceed 40 feet.
2. The minimum vertical height with roof termination is 8 feet.
3. Any combination of rise and run can be used as long as they are within the allowable limits shown on the chart below.
4. A maximum of 4 x 90 degrees elbows—or equivalent (2 x 45 degrees = 90 degrees)—can be used.
5. Each 90 degrees elbow installed on the horizontal plane is equivalent to a 3 feet horizontal pipe; therefore, 3 feet must be subtracted from allowable horizontal run. (45 degrees elbow is equivalent to 18 inches horizontal pipe.)
6. All horizontal pipe runs must be graded 1/4 inch per foot upwards in the direction of the exhaust flow. The final pipe length, when terminating through the wall may be graded downwards slightly to prevent water migration.
7. Maximum co-linear venting is 40 feet.
8. A restrictor is required for all installations—see *Restrictors* page 17 for more information.

Venting Charts Allowable Co-Axial Vent Configurations with Vertical Rise

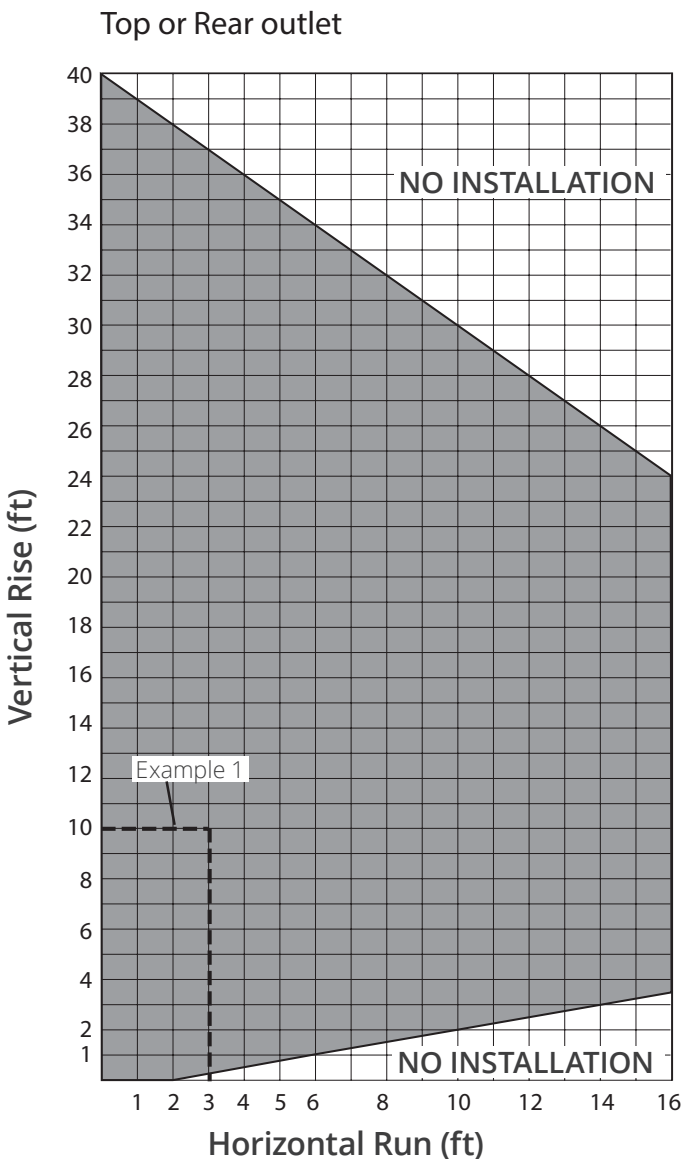

Example 1
 Value V = V1 (6') + V2 (4') = 10'
 Value H = H1 (2') + H2 (1') = 3'

Co-Axial Vertical Installations

- Check the roof pitch to determine which roof flashing will be needed. See *Approved Venting Components* pages 38–39 for allowable components.
- The distance from the roof to the lowest terminal discharge opening (“H” in figure) depends on the roof pitch and must be in accordance with the manufacturer’s instructions supplied with the termination unit. *Note: The venting system for these appliances is considered to be **Special Venting System**. The rule in the CAN/CGA-B149 Installation Code requiring a minimum vent height of 2 feet above any portion of a building within 10 feet does not, therefore, apply.*
- The minimum clearances to combustibles all round the vent pipes must be in accordance with the dimensions shown in *Venting Configurations—With Vertical Rise* page 14 of this manual.
- Drop a plumb from the ceiling to the center of the appliance vent opening. Mark the position on the ceiling. Drill a small hole at the marked position.
- Determine the position where the vent will pass through the roof. If directly above the position where it penetrates the ceiling, drop a plumb from the roof to the small hole in the ceiling and mark the roof at this spot. If rafters or other obstructions will prevent a vertical exit or if clear attic space is desired, the roof outlet can be offset using 45 degree elbows. Drill a small hole at the marked position.
- A ceiling firestop must be installed at the second floor and higher floors. A ceiling support should be used below the flat ceiling. To install the firestop and support, cut and frame a 10 inches (254 mm) square hole centered on the small hole previously drilled.
- Fit vent accessory elbows a pipe lengths as required up through ceiling support boxes and firestops. If installation includes offset, support the offsetting pipes every 3 feet (1 m) with wall straps as shown.
- Cut a hole in the roof centered on the small hole. The hole must allow for the minimum clearances to combustibles. See Venting section in this manual.
- Fit pipe lengths through the roof. Fit roof flashing securing it with roofing nails.
- Fit storm collar and termination cap.
- **FS installations.** Secure the appliance to the floor or wall if necessary.

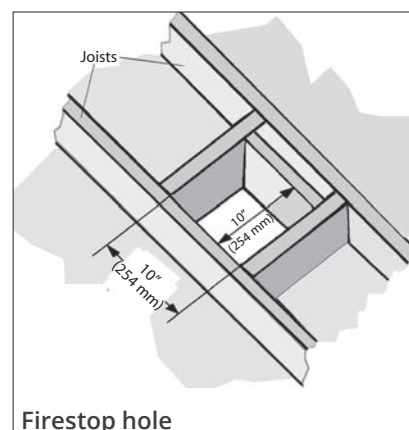
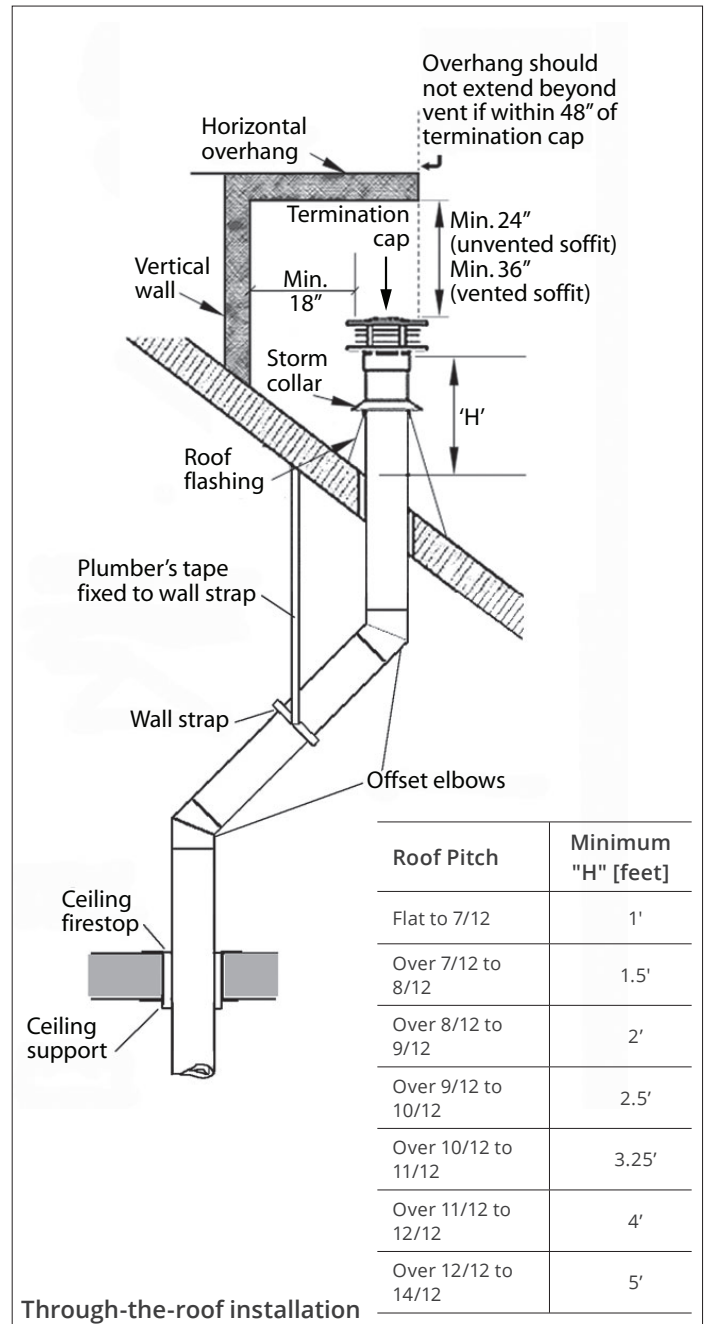

Venting

Restrictors

Install Air Restrictors—Appliances with Vertical Vent Rise Only

No restrictors are required for appliances which only have a horizontal vent run. If installing an appliance which has a rear vent facing outlet connection and no vertical vent pipe rise, ignore this stage.

Two restrictor sets, like the one shown at right, are supplied with each 530 appliance. The restrictors cover part of the inlet air openings in the firebox rear wall on each side of the brick support. **DO NOT install the restrictors in the roof of the firebox!**

Each restrictor set includes an adjustable piece which can be moved to different positions depending of the vent configuration. See the table below to find out which position is optimal for each type of installation.

- To fit the restrictors, loosen the two center screws of the left and right inlet ports. Place the restrictor assembly under the screw heads and tighten the center screws.
- To set the adjustable restrictor piece, loosen the two screws, position the adjustable piece according to the diagram below and tighten the screws.

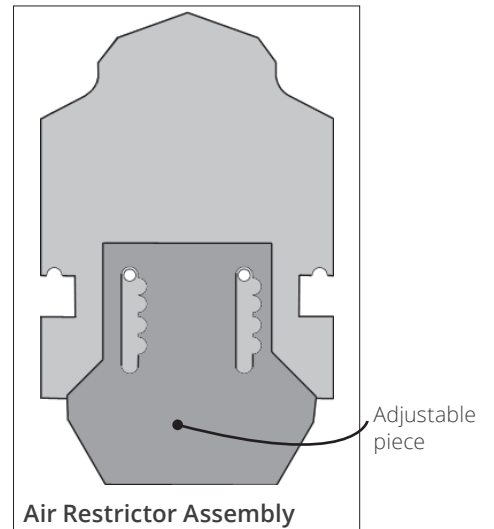

Vent terminal	Vertical vent pipe run	Use restrictor setting	
		Logs/Rocks	Coals
Horizontal through wall WITH vertical rise	Less than 4' [122 cm]		
	More than 4' [122 cm]		
Vertical through roof			

Note: NO restrictors required with straight out rear venting

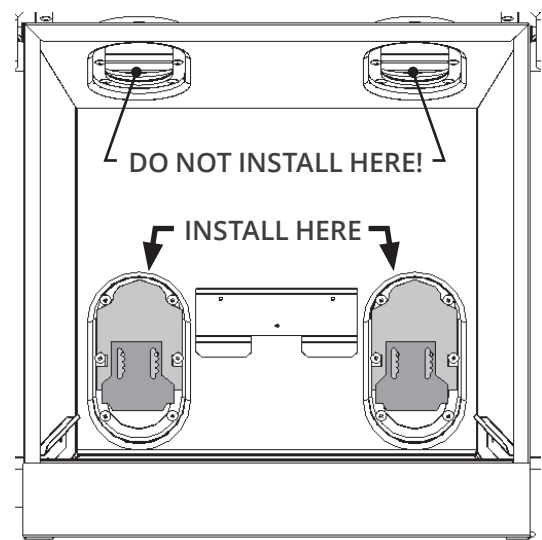

Install restrictors in the inlet air openings in the firebox rear wall behind the rear log support

Venting

Co-Linear Vent Installations into Existing Solid-Fuel Burning Fireplaces and Chimneys

See venting accessories list on pages 38-39 for allowable components.

Co-linear adapter may be installed as top or rear facing outlet—see page 23.

- Co-linear and co-axial venting may be combined in a single venting system provided conversion is done only once using approved components and maintaining proper clearances;
- Three-inch liners may only be installed into solid-fuel burning fireplaces and chimney systems (no combustible construction);
- The appliance must not be connected to a chimney flue serving a separate solid-fuel burning appliance;
- Restrictors not required for co-linear sidewall venting with less than 5'-0" vertical rise. For restrictor settings beyond 5'-0" refer to chart on page 17.

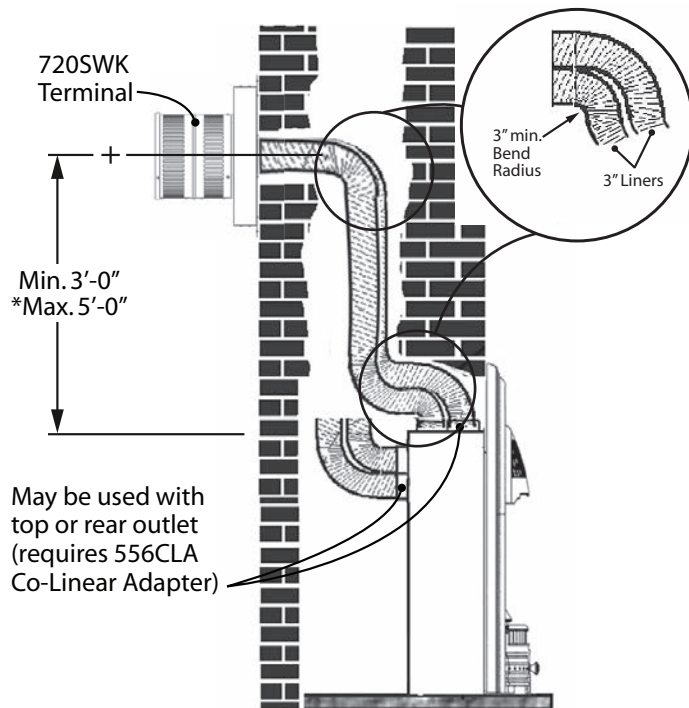
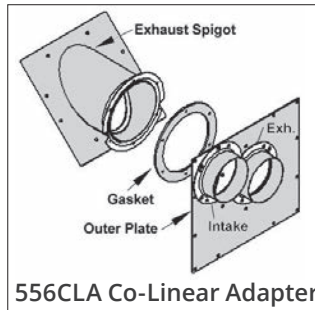

* May be extended beyond 5'-0". Refer to 720SWK installation instructions.

Sidewall co-linear installation into existing F/P using 720SWK—for units with logs, rocks, driftwood ONLY.

Co-Linear Conversion

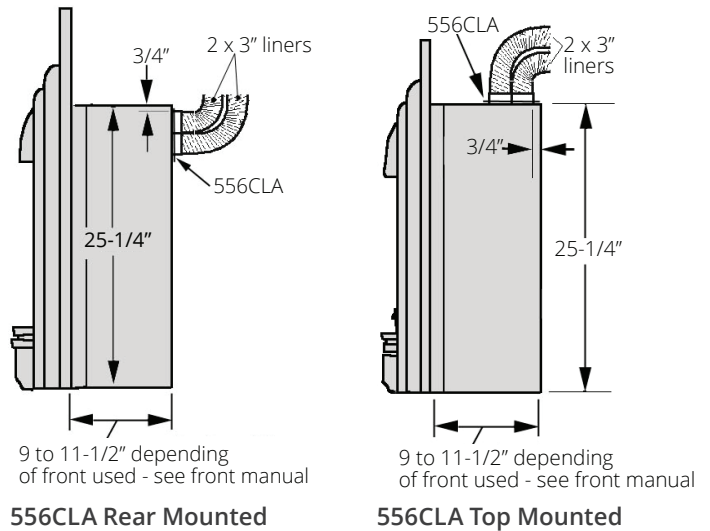

9 to 11-1/2" depending of front used - see front manual

9 to 11-1/2" depending of front used - see front manual

556CLA Rear Mounted

556CLA Top Mounted

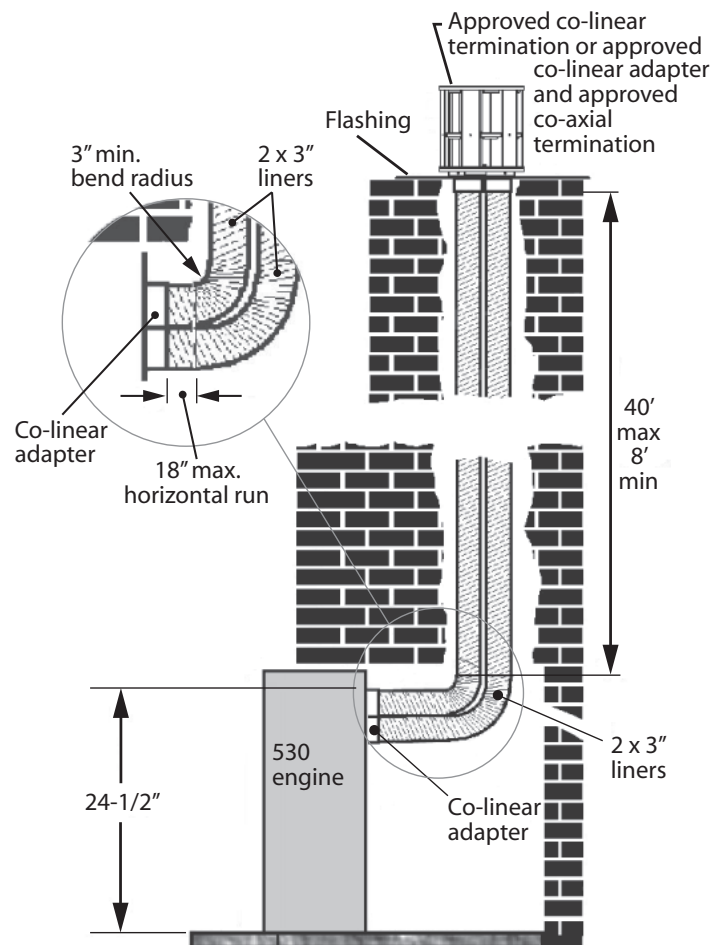

Vertical co-linear installation into existing F/P

Venting

Co-Linear Conversion

Co-Linear Venting Components

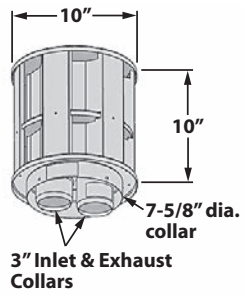

559CLT Co-linear Termination

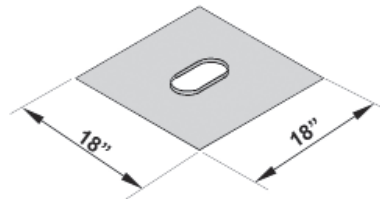

559FSK Flashing

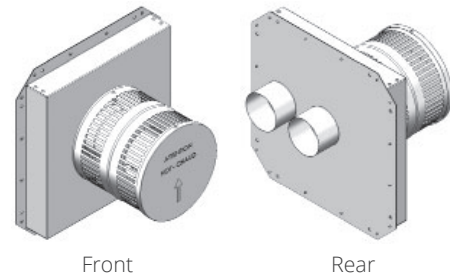

720SWK Sidewall Horizontal Terminal
(for logs, rocks, driftwood units ONLY)

Alternate to 556CLA/559CLT/559FSK Conversion for vertical terminations

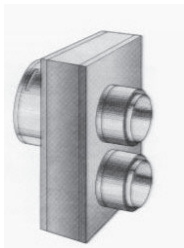

Co-Axial-to-Co-Linear Adapter

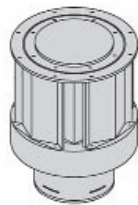

Co-axial Terminal Cap

with...

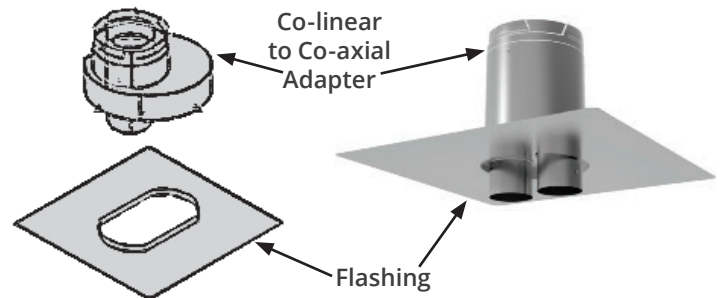

Preparation

Before Installing



Attention

ONLY qualified licensed or trained personnel should install this appliance.

1. **BEFORE YOUR START, YOU NEED TO KNOW FROM THE HOMEOWNER:**
 - Required accessories to install with fireplace (liners, fuel bed, front, trim);
 - Height of appliance and hearth, if used;
 - Thickness and type of wall finish around appliance's opening;
 - Venting configuration;
 - Optional accessories, if used.
2. Unpack the appliance, removing all items packed inside and around it. Recycle packaging.
3. Check that you have everything required for the installation, using the Pack Content sheet. Also, check that you have:
 - Fuel bed/liner panels (packed separately);
 - Front/trim/stove casing with barrier screen;
 - Venting accessories;
 - Gas conversion kit, if necessary;
 - Optional accessories;
 - Electrical accessories, if necessary.
4. **Carefully read the Installer's Checklist included with the fireplace for the installation sequence. Read also this manual and the fronts/trims manuals to have all information necessary for the installation.**



WARNING

Optional electrical accessories ARE NOT ALLOWED when adapting appliance for outdoor use.

Preparation

Window & Burner Removal

Remove Window

1. Release the top of the window by pulling forward the two levers at the top corners.
2. Unscrew the two spring-loaded bolts securing the bottom of the window.
3. Carefully lift the window away. Keep the window and bolts in a safe place.

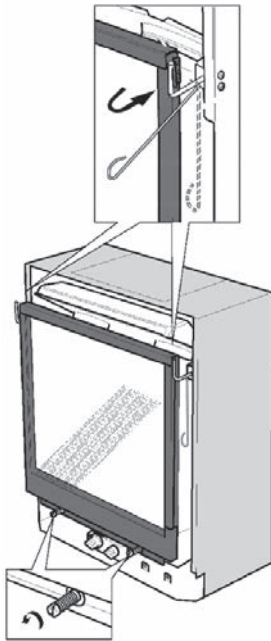

Remove Burner Module

It may be desirable to remove the burner module to gain access for gas fitting, to install a fan kit or to fasten the appliance to the floor or plinth supplied with the zero clearance fronts.

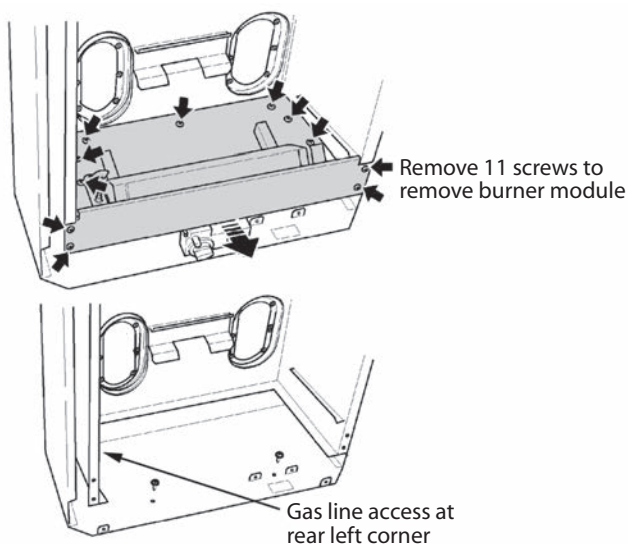

Preparation

Vent Outlet

Convert from Rear Facing to Top Facing Vent Outlet (co-axial venting)

If installing with rear facing vent outlet, ignore this stage.

1. Remove the top plate and seal by unscrewing 12 screws. Keep the seal, plate and screws for fitting to the back.
2. Remove the rear outer vent collar and seal by unscrewing 12 screws.
3. Remove the rear inner vent collar and seal by unscrewing 8 screws.

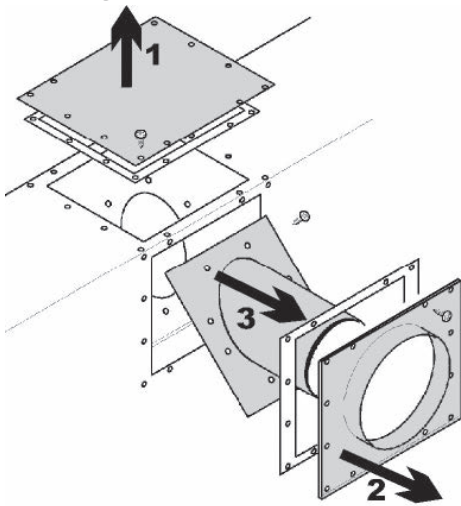

4. To make sure that the collars are axially aligned, fit the adapter 817VAK over the outer vent collar.
5. Position the inner collar and seal vertically inside the top of the appliance. Drop the outer collar with adapter over the inner collar to ensure alignment. Secure the inner collar with 8 screws and the outer collar with 12 screws.

6. Fit the plate and seal (which was previously removed from the top) to the back of the appliance with 12 screws.

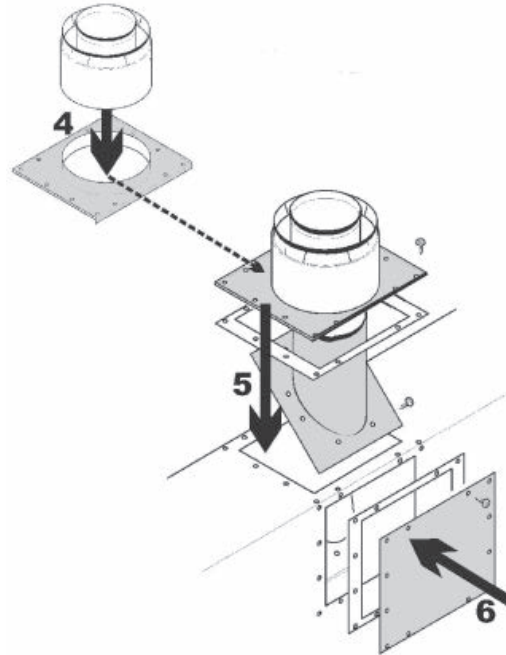

Prepare Vent Outlet

Co-axial Installations

817VAK Adapter required

1. Fit the adapter 817VAK over the appliance vent collars pushing on firmly. Align the adapter so that the seam on horizontal pipes is not at the bottom—check by temporarily fitting a pipe.
2. Drill through the adapter outer tube and appliance outer collar for #6 screws.
Make sure that the drill does not penetrate the inner tubes.
3. Secure the adapter to the outer collar with two #6 thread cutting screws supplied.

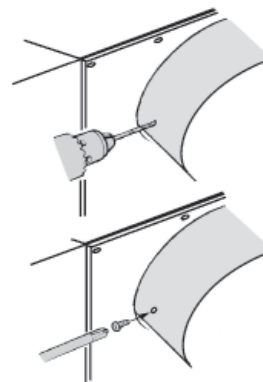

Preparation

Vent Outlet

Co-linear Installations

With 556CLA Co-Linear Adapter

See installation instructions provided with the adapter for all details.

Listed Generic Adapter Box / 817VAK Adapter

1. Fit the adapter 817VAK over the appliance vent collars pushing on firmly.
2. Fit and fully twist-lock the co-axial-to-co-linear adapter box to the 817VAK adapter.
3. Keeping the 817VAK and co-linear adapter fully twist-locked, rotate them so that the air inlet collar on the co-linear adapter is at the bottom.
4. Drill through the 817VAK adapter outer tube and appliance outer collar for no. 6 screws.
Make sure the drill does not penetrate the inner tubes.
5. Secure the 817VAK adapter to the appliance's outer collar with two no. 6 thread cutting screws supplied.

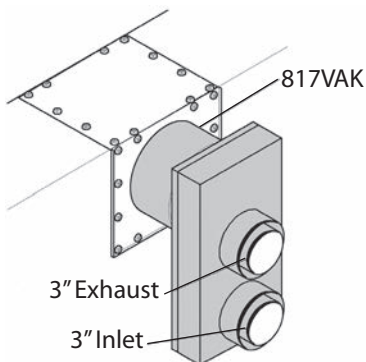

6. Continue with the installation as indicated in the co-linear adapter' installation guide.

NOTE

We recommend using hose clamps in addition to screws to secure the liners to the fireplace.

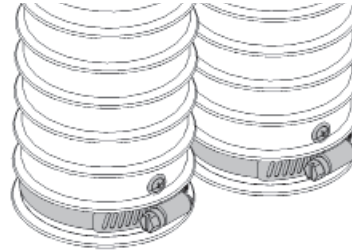

Connect Gas Supply

It is preferable to rough-in the gas line at this point before proceeding with the firebox installation.

The appliance is supplied for supply gas connection at the control valve. Supply line connection to the control valve of the appliance is 3/8" NPT female. Take care not to apply torque to the valve. An isolation valve may be fitted within the appliance case. Be aware that the supply pipe should follow routing to clear the remote receiver or optional fan.

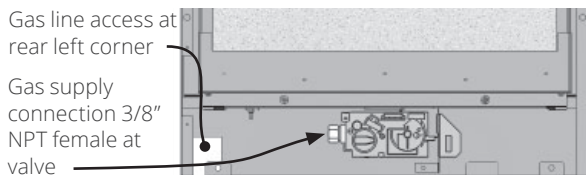

Use only new black iron or steel pipes, CSST, or copper tubing if acceptable—check local codes. **Note that in USA, copper tubing must be internally tinned for protection against sulfur compounds.**

Union in gas lines should be of ground joint type.

The gas supply line must be sized and installed to provide a supply of gas sufficient to meet the maximum demand of the appliance without undue loss of pressure.

Sealant used must be resistant to the action of all gas constituents including propane gas. Sealant should be applied lightly to male threads to ensure excess sealant does not enter gas lines.

The supply line should include a manual shut-off valve and union to allow the appliance to be disconnected for servicing.

Pressure test the supply line for leaks.

The appliance and its individual shut-off valve must be disconnected from the gas supply piping system during any pressure testing of that system at test pressures in excess of 1/2 psig (3.5kPa).

The appliance must be isolated from the gas supply piping system by closing its individual manual shut-off valve during any pressure testing of the gas supply piping system at test pressures equal to or less than 1/2 psig (3.5kPa).

Failure to either disconnect or isolate the appliance during pressure testing may result in regulator or valve damage. Consult your dealer in this case.

The minimum supply pressure is given on page 6 of this manual.

All piping and connections must be tested for leaks after installation or servicing. All leaks must be corrected immediately.

When testing for leaks:

- Make sure that the appliance is turned off.
- Open the manual shut-off valve.
- Test for leaks by applying a liquid detergent or soap solution to all joints. Bubbles forming indicate a gas leak.



WARNING

NEVER USE OPEN FLAME to check for leaks. Correct any leak detected immediately.

The pressure test tapping locations are shown below. A built-in non-adjustable regulator controls the burner manifold pressure. The correct pressure range is shown page 6 of this manual. The pressure check should be made with the burner alight and at its highest setting. See *Appendix A – Lighting Instructions Plate* page 42 for full operating details.

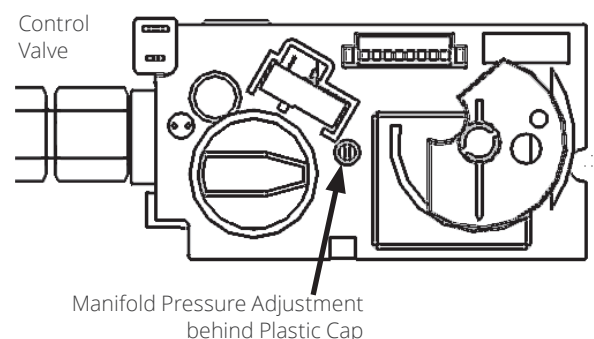
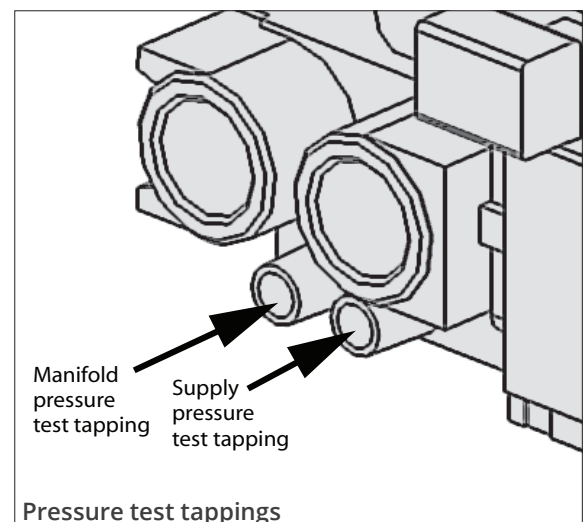

Installation

Liner Panels—Traditional Logs & Coals

Install Ceramic Liners (Logs or Coals only)

The 530LSK and CSK fuel beds include a set of reversible liners. Check with the consumer which side must be visible and follow the instructions below to install the liner set.

- **530RSK Rock Set liners.** For ceramic liners installation with the 530RSK, see *Rock Set and Liners 530RSK* in Fuel Beds section in this manual.
 - **530DWK Driftwood Kit liners.** For ceramic liners installation with the 530DWK, see *Driftwood and Liners 530DWK* in Fuel Beds section in this manual.
 - **580RGL Reflective Glass Liner Set.** To install the 580RGL, see the installation instructions provided with the kit.
 - **567FGP Top Grille.** At this point, you can install the 567FGP, if used (logs, rocks or driftwood versions only). The 567FGP Top Grille is sold separately except when included with front trim—see front trim installation manual.
1. Locate the ceramic rear wall in the channel at back of the firebox and flat against the back of the firebox.
 2. Locate the sidewalls in the channels at the sides of the firebox.
 3. Remove two screws from under the top front of the firebox. Using these screws fit the port cover.

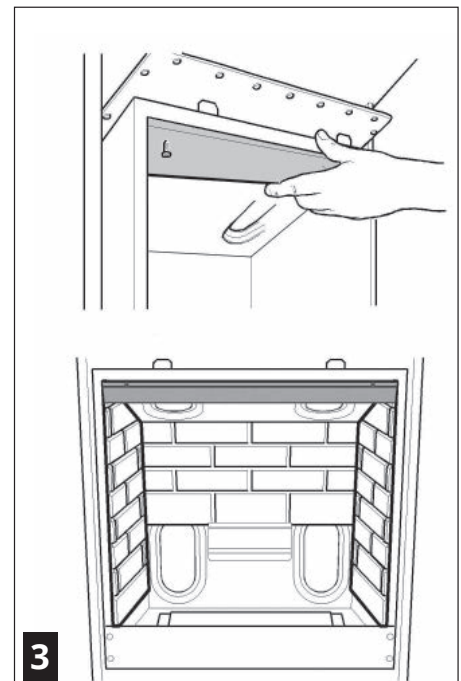
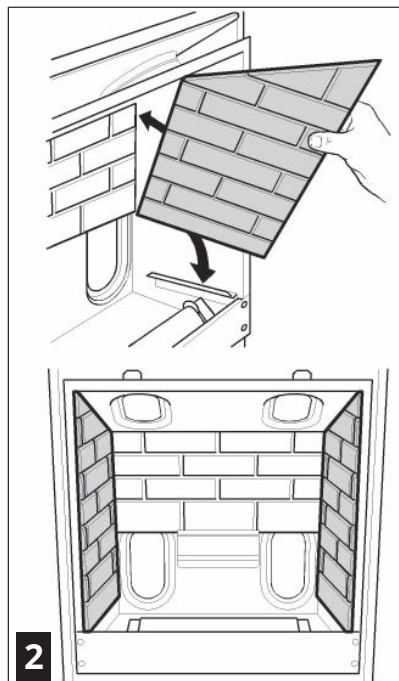
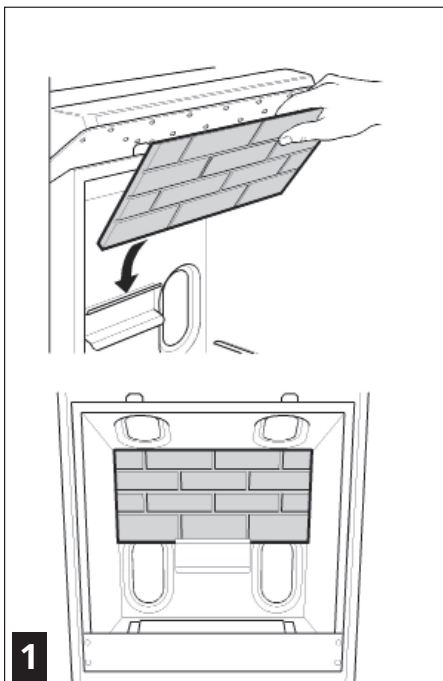

Installation

Fuel Beds

Traditional Logs Set 530LSK

1. Place the base log on the supports in the firebox and against the support at the firebox back.
2. Locate the rear upper log on the two ceramic pins at the rear of the base log.
3. Place the front log behind the metal strip at the front of the firebox.
4. Locate the right middle log on the pin in the right hand side of the base log.
5. Locate the left side log on the ceramic pin on the left hand side of the base log. Rest the narrow nose of this log on the projection at the front center of the base log—ensure that the narrow nose does not rest on the burner.
6. Locate the right side log on the pin in the front log and rest the nose of this log on the projection on the base log—ensure that the nose does not rest on the burner.

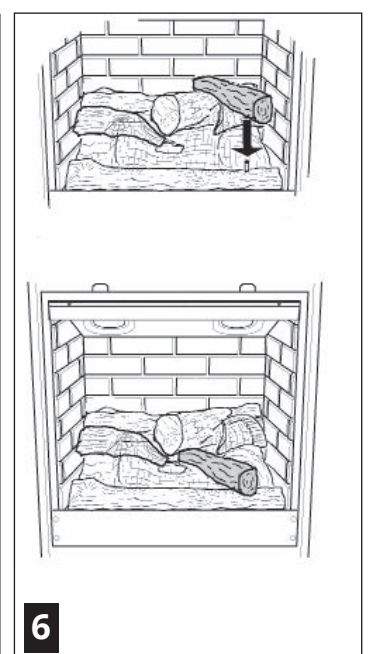
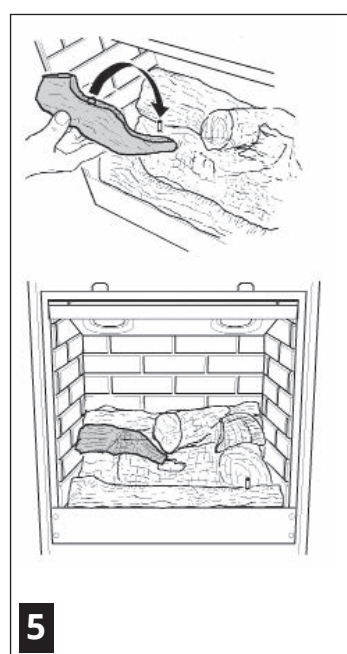
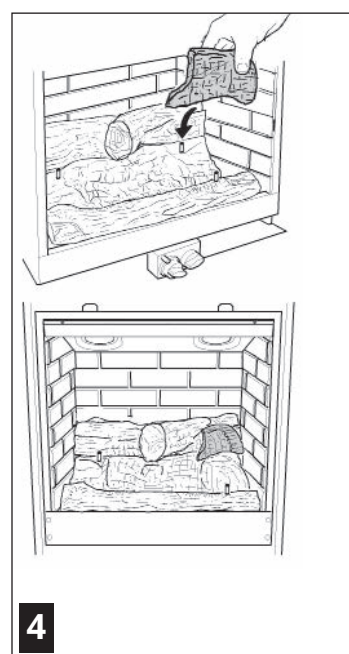
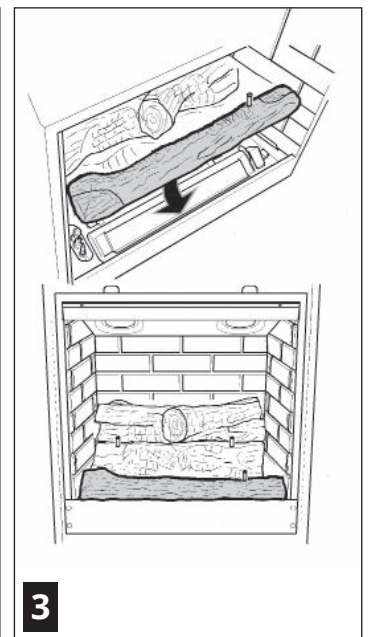
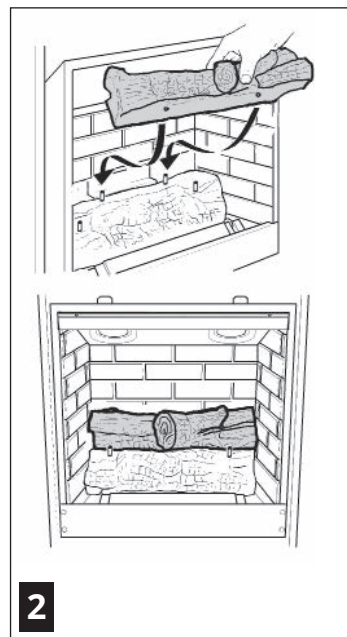
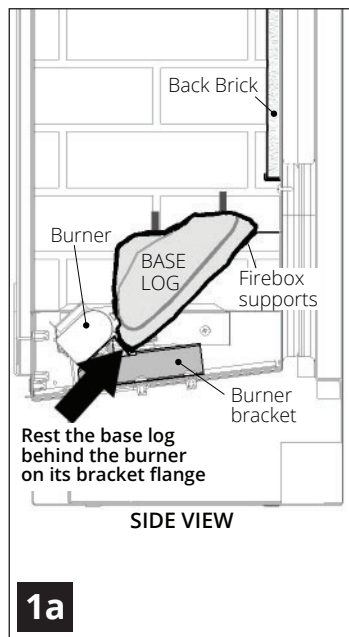
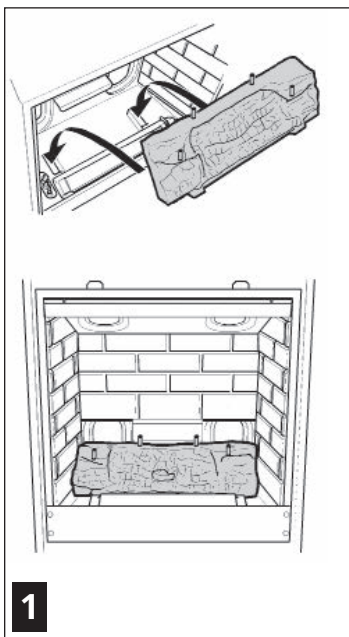

Installation

Fuel Beds

Coal Set 530CSK

1. Place the base coal on the supports in the firebox and against the firebox back.
2. Place the left front coal in position behind the metal lip at the front of the firebox. The side projection on this coal should be near the middle front of the firebox.
3. Place the right front coal behind the metal lip at the front of the firebox. Its left side should rest over the projection on the left front coal.
4. The center right coal has letter "R" embossed underneath. Place this coal behind the front right coal.
5. The center left coal has letter "L" embossed underneath. Place this coal behind the front left coal.

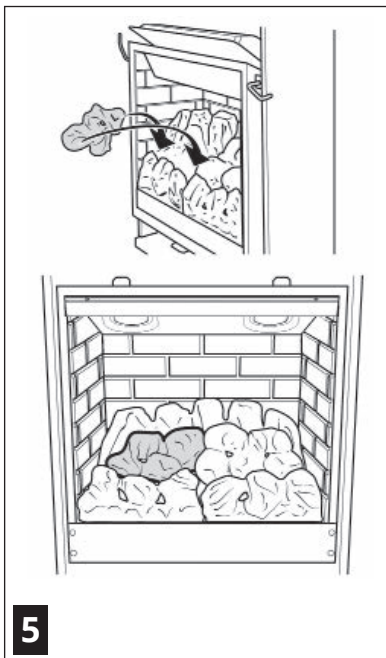
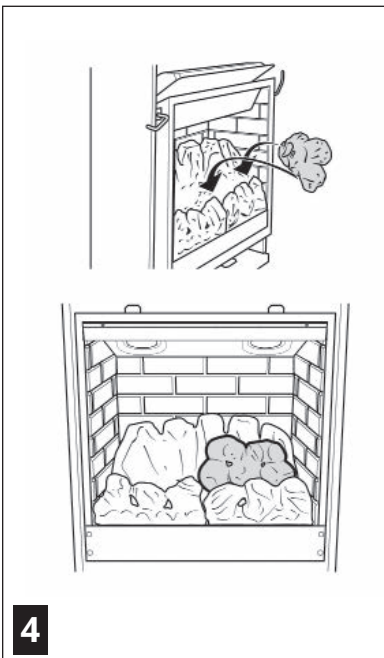
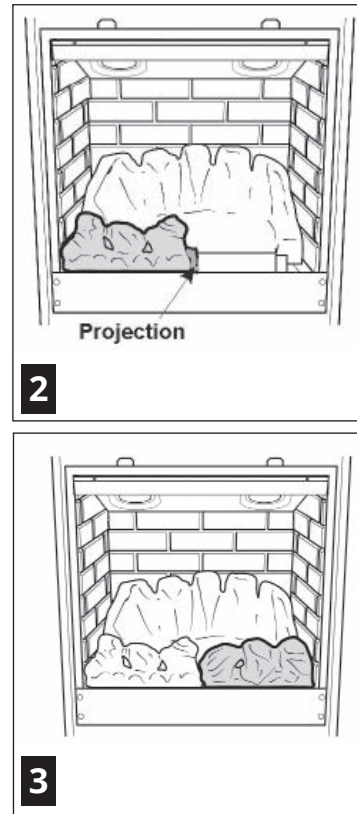
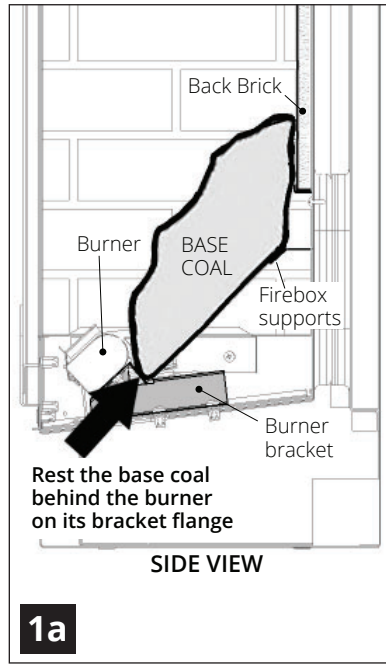
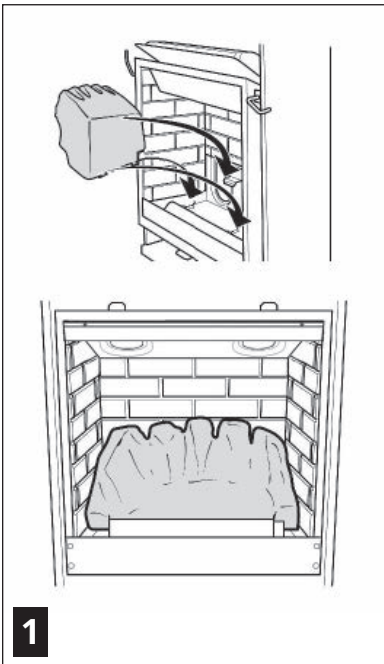

Installation

Fuel Beds

Rock Set and Liners 530RSK

Unpack each piece of the ceramic rock set carefully to avoid damages. The set contains:

- Ceramic platform
- Left and right side reversible ceramic panels
- Rear panel support
- Rear fluted panel
- Ceramic base for rocks
- 12 ceramic rocks

580RGL Reflective Glass Liner Set. To install the 580RGL, see the installation instructions provided with the kit.

Install liners

1. Remove the rear panel support inside the firebox (3 screws).
2. Replace with the rear panel support provided with the 530RSK kit and fix it (3 screws).
If installing the 567FGP Top Grille (sold separately), fit it now. See instructions supplied with the grille.

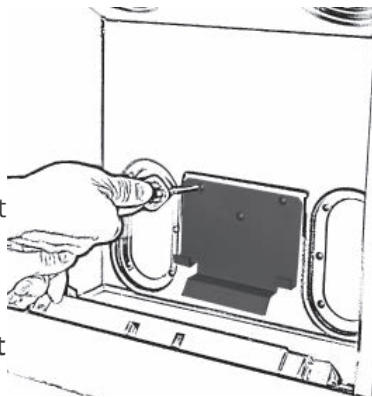

3. Place the rear panel on the rear support as indicated. Hold in place and go to next step.

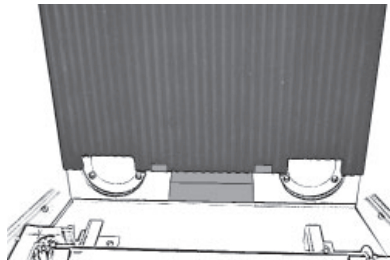

4. Place the left and then the right panels in the firebox showing the black fluted sides.

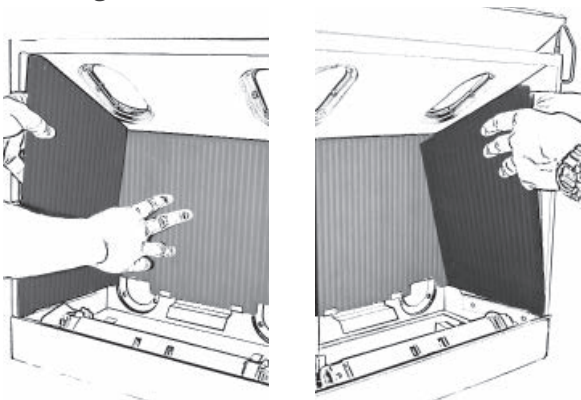

Install rock base & platform

1. Place the rock base behind the burner. The two protrusions in front of the base should rest on the burner mounts as indicated.

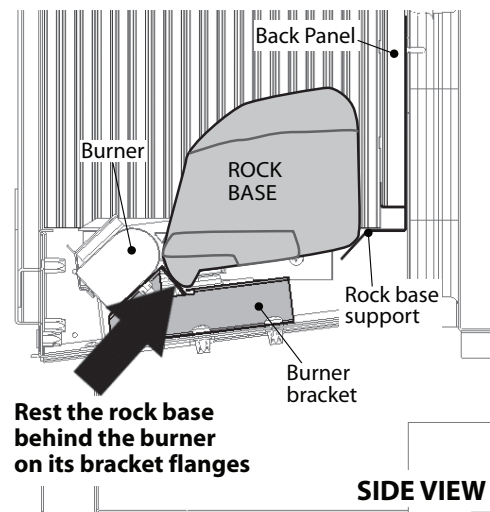
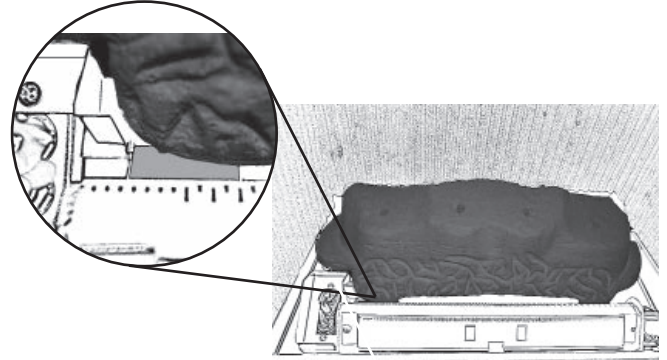

2. Place the ceramic platform over the burner and around the rock base with the pegs on the top. The rear part of the platform should overlap the edges of the rock base on each side.

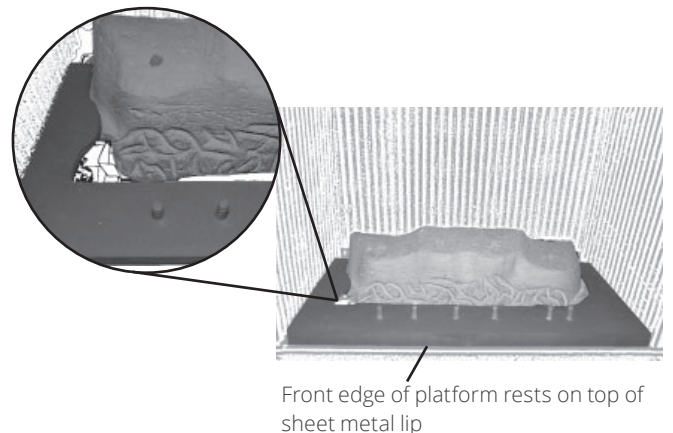

Installation

Fuel Beds

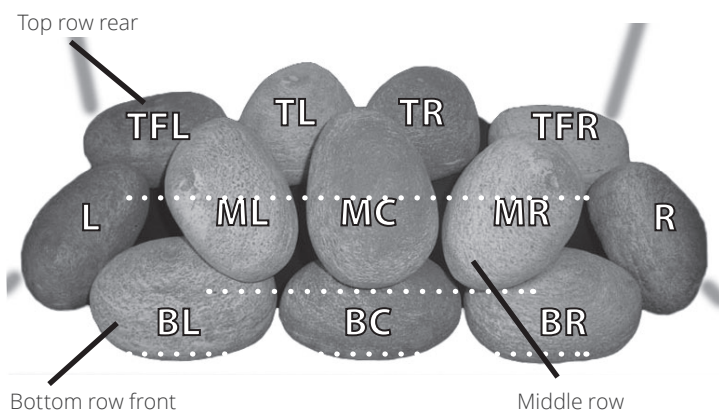

Install rocks

To get the optimal flame effect, it is important to place the rocks in their appropriate position. Each rock is embossed underneath with letters and an arrow indicating the position of the rock. **The arrows point to the front of the fireplace when the rock is installed.** See the image and table at the top of the page to help you with the identification and position of the rocks.

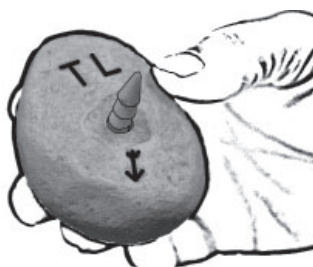

1. Identify the rocks **TFL, TL, TR, and TFR**. These rocks have pegs that fit in the holes on the top of the rock base. Install these rocks positioning them so that the arrow embossed underneath point to the front of the fireplace.
2. Identify the rocks **BL, BC, and BR**. These rocks have two holes that fit on the pegs of the ceramic platform. Install these rocks positioning them so that the arrow embossed underneath point to the front of the fireplace.

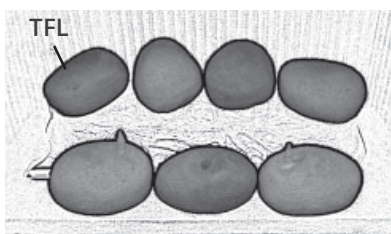
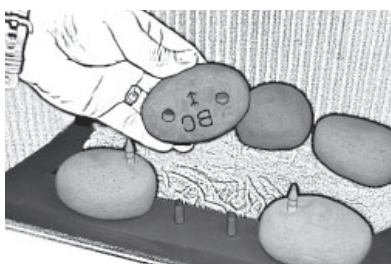

Rock ID	Description	Other markers	Position in the firebox
TFL	Top far left	1 peg under	Top row rear
TL	Top left	1 peg under	Top row rear
TR	Top right	1 peg under	Top row rear
TFR	Top far right	1 peg under	Top row rear
BL	Bottom left	2 holes under, 1 peg above	Bottom row front
BC	Bottom center	2 holes under, 1 hole above	Bottom row front
BR	Bottom right	2 holes under, 1 peg above	Bottom row front
ML	Middle left	1 hole under	Middle row
MC	Middle center	1 peg under	Middle row
MR	Middle right	1 hole under	Middle row
L	Left	—	Left side
R	Right	—	Right side

3. Identify the rocks **ML, MC, and MR**. Those rocks have pegs that fits in the holes on the top of the rocks on the front row. Install those rocks positioning them so that the arrows underneath point to the front of the fireplace.

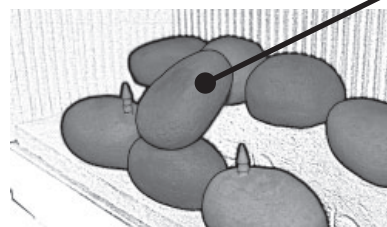
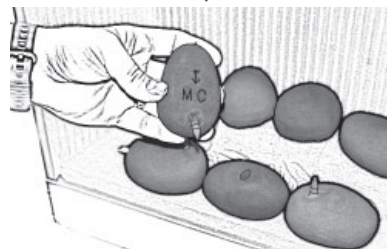

This rock is held by a peg and does not touch the rocks of the back row

4. Identify the rocks **L and R**. Those rocks don't have any peg or hole. Install those rocks as indicated, at the left and right of the rock pile positioning them so that the arrows underneath point to the front of the fireplace. The rock rests against the other rocks and is at an angled position. *Make sure that the TFL rock at the rear left is in the proper angle*—see image in step 2. See the image at the top of the page.

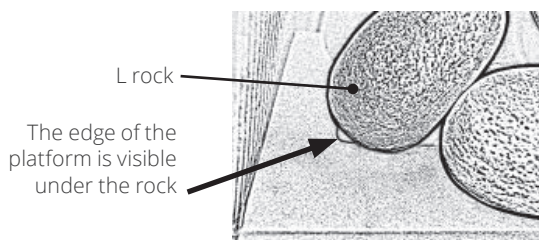

You must be able to see the edge of the platform under the L rock as indicated at left.

Installation

Fuel Beds

Driftwood Kit and Liners 530DWK

Unpack each piece of the ceramic driftwood set carefully to avoid damages. The set contains:

- Metal platform
- Left and right side reversible ceramic panels
- Rear panel support
- Rear fluted panel
- 5 driftwood logs
- 4 ceramic pebbles

580RGL Reflective Glass Liner Set. To install the 580RGL, see the installation instructions provided with the kit.

Install liners

1. Remove the rear panel support inside the firebox (3 screws).

2. Replace with the rear panel support provided with the 530DWK kit and fix it (3 screws).

If installing the 567FGP Top Grille (sold separately), fit it now. See instructions supplied with the grille.

3. Place the rear panel on the rear support as indicated. Hold in place and go to next step.

4. Place the left and then the right panels in the firebox showing the black fluted sides.

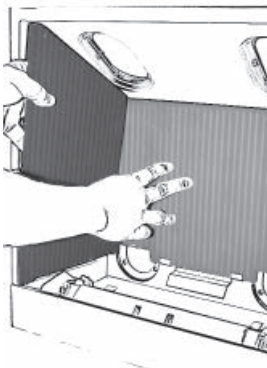
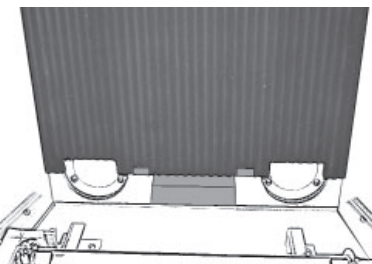
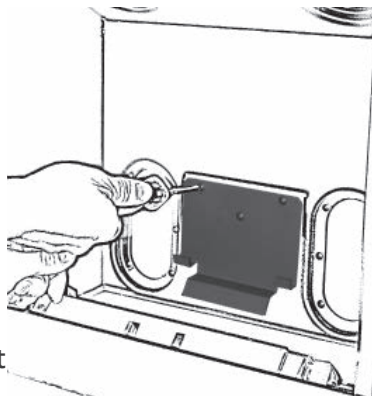

Install platform, driftwood logs and pebbles

1. Place the protrusion at the back of the base log on the ledge of the rear panel support as far back as it will go. Then pull the log evenly towards the front until it rests against the burner supports.

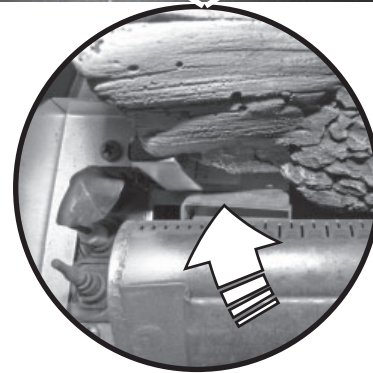
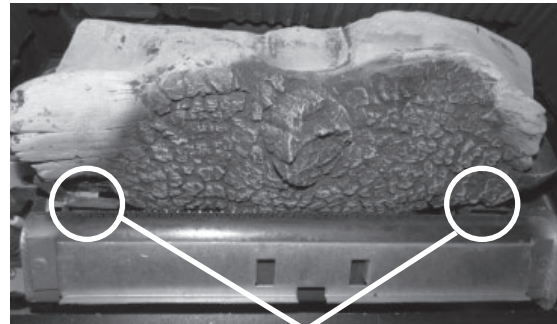
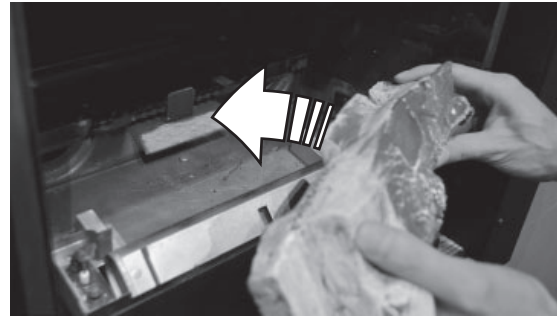

2. Place the metal platform and centre it over the burner and around the base log with the pegs on the top. The front of the platform must rest on the edge of the firebox. The right end rests of the base log.



Installation

Fuel Beds

3. Place the rear log on top of the base log locating it into the notches on top of the base log.

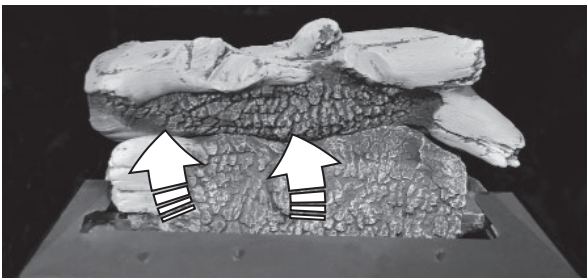

4. Place the centre log on the platform inserting the peg into the hole on the log as indicated. Line up the log parallel to the platform.

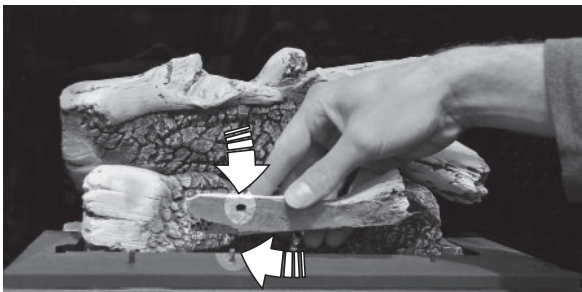

5. Place the right log inserting the platform peg into the hole at the end of the log; rest the upper end of the log in the notch on the rear log as indicated.

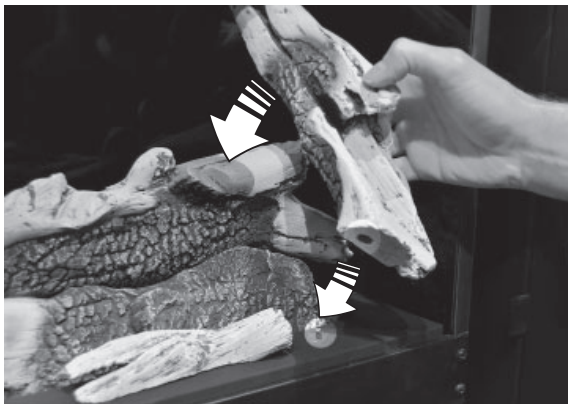

6. Place the left log inserting the platform peg into the hole at the end of the log; rest the upper end of the log in the notch on the rear log as indicated.

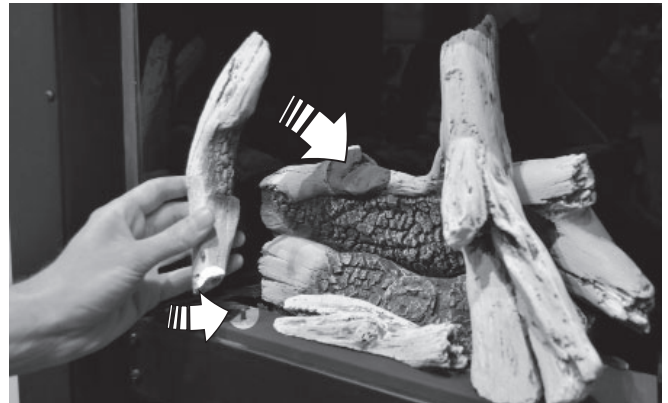

7. Place one larger pebble on each end of the platform to cover its edge as indicated; place the smaller pebbles on the platform in front the larger ones as indicated.



Installation

Refit & Check Window

Refit and Check Window

1. Rest the window on the support at the base of the firebox and center it on the width.
2. While pressing the window against the firebox, pull the clamping bars levers forward and rotate them inwards to secure the top of the window.
3. Fit the two spring-loaded bolts through the bottom of the window and tighten to secure the window.
4. Pull the top of the window forward and release to check that it opens slightly and returns confirming the good function of the spring-loaded mechanism.

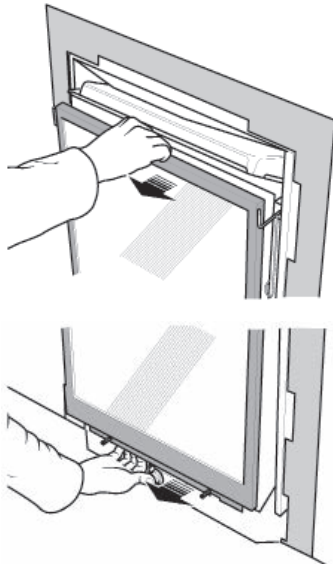
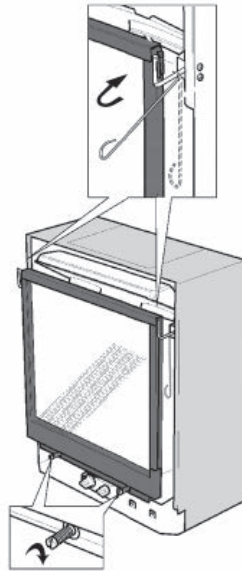

5. Similarly, check the bottom of the window by pulling it forward and releasing it.
6. Apply firm pressure around the window frame to ensure the window is sealed tight against the firebox.
7. If the Hot Glass Warning plate has been removed from the front lower corner of the window, re-install it by sliding it between the glass and the frame as indicated.

! WARNING

The window unit must be correctly installed, fastened and sealed after servicing or serious bodily injury and/or damage to the appliance may result.

To ensure a safe operation:

- Double-check that the window frame is correctly installed;
- Verify that the levers and spring-loaded bolts are hooked properly to the window tabs then;
- Pull out the top of the window and release it to ensure the springs return it; repeat with the bottom of the window;
- Ensure the window is sealed before operation.

! WARNING

Failure to install the window correctly can:

- Leak carbon monoxide;
- Affect the performance of the fireplace;
- Damage components;
- Cause overheating resulting in dangerous conditions.

Damages caused by incorrect window installation is not covered by the Valor warranty.

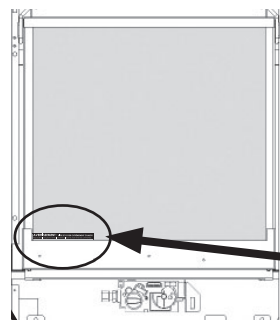

! WARNING: EXTREMELY HOT GLASS AND FIREPLACE
Risk of severe burns. Keep Children away from fireplace & controls.
Risque de brûlures graves, tenez les enfants à l'écart du foyer et de ses commandes.
AVERTISSEMENT : VITRE ET FOYER EXTREMEMENT CHAUDS
Hot Glass Warning plate

! WARNING: EXTREMELY HOT GLASS AND FIREPLACE
Risk of severe burns. Keep Children away from fireplace & controls.

Installation

Battery Holder

Install Battery Holder

The batteries that power the receiver and handset need to be installed prior to pairing and use.

1. Take the receiver out from under the firebox.
2. Insert four 1.5 V high quality **alkaline** batteries in the battery holder and one high quality **alkaline** 9 V battery in the remote handset. The battery holder and cable are supplied with the appliance.



3. Connect the cable to the receiver as shown.

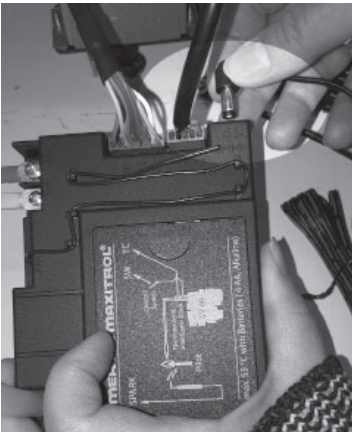

4. Connect the other end of the cable to the battery holder.

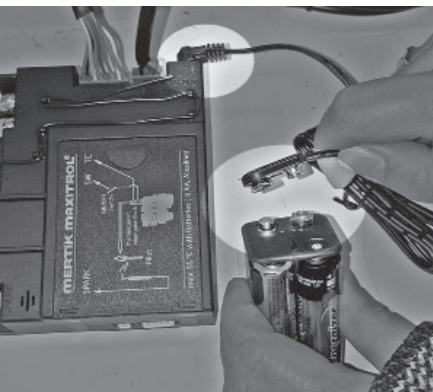

5. Place the receiver and battery holder as shown below (placement may vary with installed options).

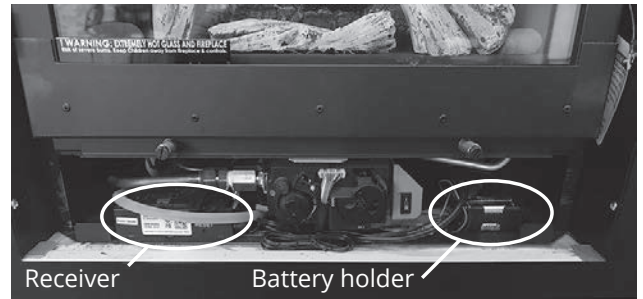

6. Use a heat-resistant tie to gather any extra cable between the receiver and the holder.

Caution

DO NOT let the cable touch the burner plate above, it will melt during operation.

Installation

Remote Control Pairing

Synchronize Receiver and Handset

The receiver and handset of the remote control system must be initially paired before the first use.

1. If not already done, place a 9 V **alkaline** battery in the handset.
2. Identify the RESET button on the front of the receiver.
3. With a thin object, press and hold the receiver's reset button until you hear one short and one long beep. Release the button after the second beep.
4. Within the next 20 seconds, press the small flame button () on the handset until you hear two short beeps confirming the pairing is set.
If you hear a long beep, the pairing has not been done or the wires are not connected correctly.

This is a one time setting only and is not required when changing the batteries in the remote handset. The remote control system is now ready to use.

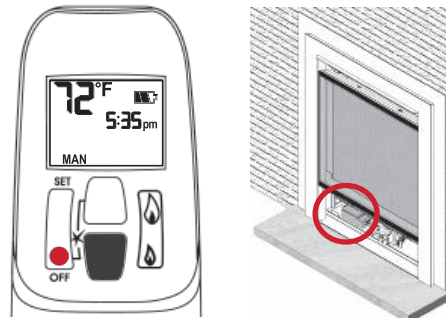

Installation

Burner aeration

Check Operation

Turn the fireplace flame up and down using the remote control to confirm that the full range of inputs is achieved—see *Appendix B - Remote Control Operation* pages 43–46 for details.

Adjust Aeration (if needed)

Light the fire and allow the unit to warm up for 10–15 minutes to evaluate the flame picture. Burners are equipped with an adjustable shutter to control primary aeration. See figures below. The shutter is factory-set to an aeration gap which will give optimum performance for the vast majority of installations.

In some installations, depending of the fuel bed used, the altitude and other considerations, the flame picture may be improved by adjusting the aeration. The need for adjustment should be determined only by operating the appliance with the fuel bed and window installed and evaluating the flame picture after a 15-minute warm-up.

Increasing aeration (open) will cause the flames to appear more transparent and blue showing more ceramic effects glow.

Decreasing aeration (close) will cause flames to appear more yellow or orange showing less ceramic effects glow.

Too little aeration may result in black carbon forming and dropping into the firebox.

Air Shutter

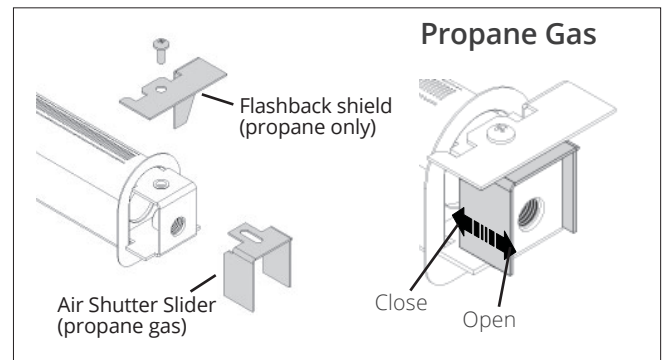
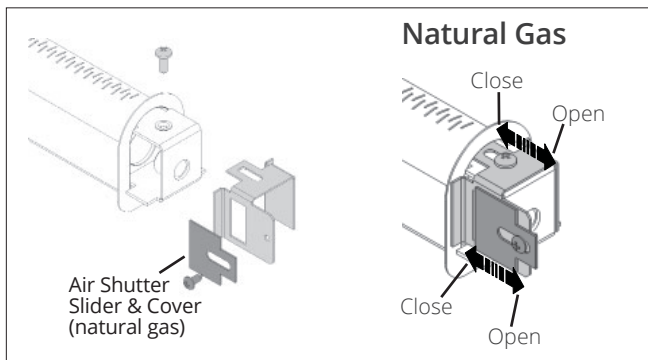

Front and Barrier Screen

Install the front chosen by the customer for the fireplace. Install as well the barrier screen which is provided with the front.

Show the customer how to access the controls when the front is installed and how to remove it.

Follow the instructions provided with the front and leave those instructions behind for the customer's further reference.

Handset Wall Holder

The remote control kit for this fireplace comes complete with a wall-mounted holder. This holder is not required in all installations but is provided as an optional feature for those customers who wish to mount the remote handset to the wall.

To install the holder to the wall, find a convenient location and use the hardware provided with the kit. See the diagram below for required hardware and configurations. Note that the holder can be installed at the base of a light switch plate.

IMPORTANT. The location of the remote control handset is important to insure proper temperature regulation. To obtain a constant temperature, we recommend that the handset should be between 3 and 15 feet away from the appliance but not directly above it. We also advise that the handset should be located away from any other heat source and not in direct sunlight as this may affect the temperature sensor located in the remote handset.

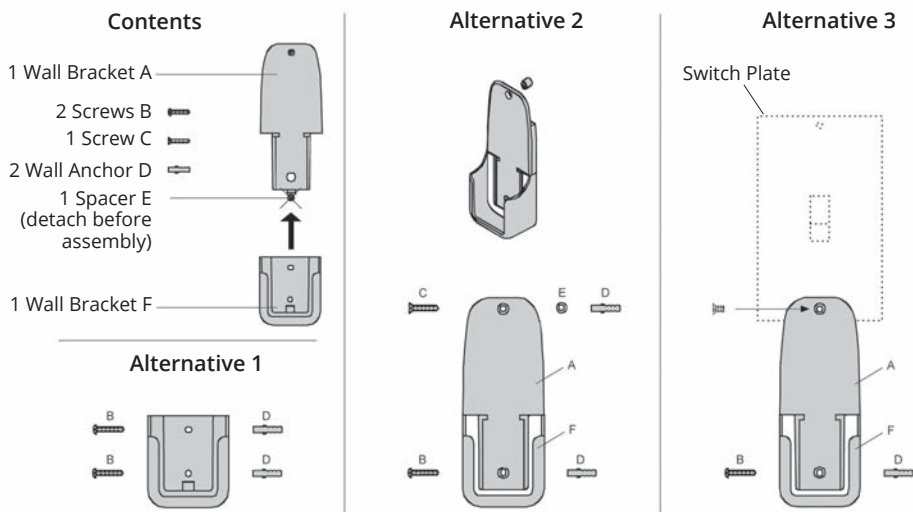

Wiring Diagram

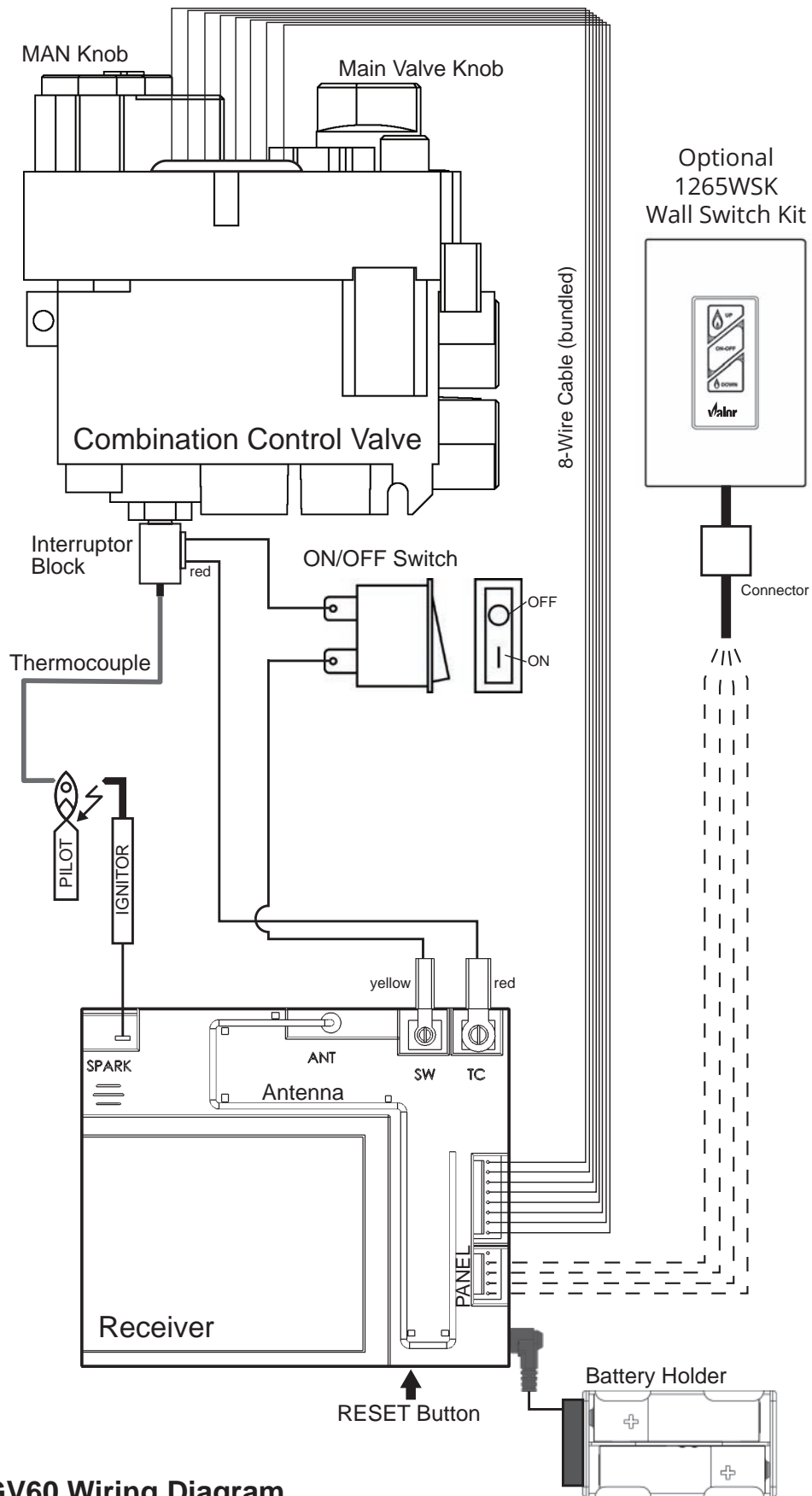

GV60 Wiring Diagram

Approved Venting Components

Approved Direct Vent Suppliers for Valor Models 530 ⁶ , 534, 650 and MF28 ⁷										
Venting Parts Description		Venting Parts Code / availability by Manufacturer								
		DURA-VENT	SELKIRK	ICC EXCEL DIRECT	SECURE VENT	RLH INDUSTRIES	AMERIVENT	MILES INDUSTRIES	BDM	
Termination Caps	Horizontal	Standard Co-axial	46DVA-HC	4DT-HC	TM-4HT	—	—	4DHC round	658DVK2	940160
		Deluxe Co-axial	—	—	TM-4RHT	—	—	4DHCS square	—	940160
		High Wind Co-axial	—	—	—	SV4CHC	—	—	—	—
	Vertical	Standard Co-axial	46DVA-VC	4DT-VT	—	—	HSDV4658-1313	4DVC	—	940264
								4DH-1313		940364
								—		940206LP
		High Wind Co-axial	46DVA-VCH	—	TM-4SVT	SV4CGV	—	—	—	—
		Extended Co-axial	46DVA-VCE	—	—	—	—	—	—	—
		Co-linear	46DVA-CL33	—	TM-IVT	3PDVCV	HS-C33U-99	HCL-99-33	559CLT	940033B
			46DVA-CL33H					HCL-913-33		—
46DVA-33P	HS-C33F-1313		HCL-1313-33					720SWK ⁶		940033HWS
Snorkel, 14" Rise	46DVA-SNK14	4DT-ST14	TM-4ST14	—	—	—	4D14S	—	94040614	
Snorkel, 36" Rise	46DVA-SNK36	4DT-ST36	TM-4ST36	—	—	—	4D36S	—	94040636	
Vent Adapters / Couplers	Universal Adapter 3" Flex Coupler	2150	—	TM-CFAA3	—	—	—	—	95090390	
	Valor Adapter	817VAK	—	TM-4AA2	—	—	4DSC-V	—	—	
	Co-linear Flex Connector	46DVA-ADF	—	—	—	—	—	—	—	
	Co-axial-to-Co-linear Adapter	46DVA-GCL 46DVA-CLAA	—	TM-4CAA	—	—	4DCAB33	556CLA	940106433	
	Co-linear-to-Co-axial Adapter	46DVA-GK 46DVA-CLTA	—	TM-4CTA	—	—	4DCAT33	—	—	
	DV to B-Vent Adapter	—	—	—	—	—	—	DVA5BV ⁷	—	
Aluminum Flexible Liner	3" or 4" diameter	NOTE: 2-ply liner approved to CAN/ULC S635 suitable for venting gas appliances. As manufactured by Z-Flex, Flexmasters or others.								
		2280 Series	AF3-35L	TM-ALK33 TM-ALT33	—	—	—	—	—	952703 952704
Adjustable Pipe Length and Pipe Extensions 4" x 6-5/8"	Galvanized or Black	46DVA-08A 46DVA-08AB (3" to 7")	4DT-ADJ 4DT-ADJ(B)	—	—	—	4D7A or 4D7AB (3" to 5")	—	94610608 (4" to 8-1/2")	
		46DVA-16A 46DVA-16AB (3" to 14-1/2")	—	TC-4DLS1 TC-4DLS1B	SV4LA SV4LBA	—	4D12A or 4D12AB (3" to 10")	—	94610616 (4" to 16")	
	Galvanized or Black	46DVA-17TA 46DVA-17TAB (11" to 17")	—	TC-4DLS2 TC-4DLS2B (1-7/8" – 21")	SV4LA12 SV4LBA12	—	4D16A or 4D16AB (3" to 14")	—	—	
		46DVA-24TA 46DVA-24TAB (17" to 24")	—	TC-4DLA30 TC-DLA30B (16.5" – 29")	SV4LA24 SV4LBA24	—	4D26A or 4D26AB (3" to 24")	—	—	
	Co-axial Flex		46DVA-36FF 46DVA-60FF 46DVA-120FF	—	—	—	—	—	—	—
	DV 45° Elbows	Galvanized	46DVA-E45	—	TE-4DE45	—	—	4D45L	—	94620645
Black		46DVA-E45B	—	TE-4DE45B	SV4EBR45	—	4D45LB	—	94620645B	
Galvanized Swivel		—	4DT-EL45	—	SV4E45	—	—	—	—	
Black Swivel		—	4DT-EL45(B)	—	SV4EB45	—	—	—	—	
DV 90° Elbows	Galvanized	46DVA-E90	—	TE-4DE90	—	—	4D90L	—	—	
	Black	46DAV-E90B	—	TE-4DE90B	SV4EBR90	—	4D90LB	—	—	
	Galvanized Swivel	—	4DT-EL90	—	SV4E90	—	—	—	94620690	
	Black Swivel	—	4DT-EL90(B)	—	SV4EB90	—	—	—	94620690B	

Approved Venting Components

Venting Parts Description			Venting Parts Code / availability by Manufacturer							
			DURA-VENT	SELKIRK	ICC EXCEL DIRECT	SECURE VENT	RLH INDUSTRIES	AMERIVENT	MILES INDUSTRIES	BDM
Pipes 4" x 6 5/8" (ID x OD)	6" long	Galvanized	46DVA-06	4DT-06	TC-4DL6	SV4L6	—	—	—	94610606
		Black	46DVA-06B	4DT-06(B)	TC-4DL6B	SV4LB6	—	—	—	90410606B
	7" long	Galvanized	—	—	—	—	—	4D7	—	—
		Black	—	—	—	—	—	4D7B	—	—
	9" long	Galvanized	46DVA-09	4DT-09	TC-4DL9	—	—	—	—	94610609
		Black	46DVA-09B	4DT-09(B)	TC-4DL9B	—	—	—	—	94610609B
	12" long	Galvanized	46DVA-12	4DT-12	TC-4DL1	SV4L12	—	4D12	—	94610612
		Black	46DVA-12B	4DT-12(B)	TC-4DL1B	SV4LB12	—	4D12B	—	94610612B
	18" long	Galvanized	46DVA-18	4DT-18	—	—	—	—	—	94610618
		Black	46DVA-18B	4DT-18(B)	—	—	—	—	—	94610618B
	24" long	Galvanized	46DVA-24	4DT-24	TC-4DL2	SV4L24	—	4D2	—	94610624
		Black	46DVA-24B	4DT-24(B)	TC-4DL2B	SV4LB24	—	4D2B	—	94610624B
	36" long	Galvanized	46DVA-36	4DT-36	TC-4DL3	SV4L36	—	4D3	—	94610636
		Black	46DVA-36B	4DT-36(B)	TC-4DL3B	SV4LB36	—	4D3B	—	94610636B
	48" long	Galvanized	46DVA-48	4DT-48	TC-4DL4	SV4L48	—	4D4	—	94610648
		Black	46DVA-48B	4DT-48(B)	TC-4DL4B	SV4LB48	—	4D4B	—	94610648B
Flashings	Roof Flashing 0/12-6/12		46DVA-F6	4DT-AF6	TF-4FA	SV4FA	—	4DF (0/12-5/12)	—	949606012
	Roof Flashing 7/12-12/12		46DVA-F12	4DT-AF12	TF-4FB	SV4B	—	4DF12 (6/12-12/12)	—	949606712
	Flat Roof Flashing		46DVA-FF	—	TF-4F	SV4F	—	—	559FSK	949606001
	Masonry Flashing		—	—	TF-4MF	—	—	—	—	—
	New Siding Flashing		—	—	—	—	—	—	658NSFK	—
Various Venting System Parts	Wall Thimble		46DVA-WT	4DT-WT	TM-4WT	SV4RSM	—	4DWT	—	949064U
	Storm Collar		46DVA-SC	4DT-SC	TM-SC	SV4AC	—	4DSC	—	94960608
	Decorative Plate		46DVA-DC	4DT-CS	TM-4TR TM-4TP	SV4PF	—	4DFPB	—	94940612
	Cathedral Ceiling Support		46DVA-CS	4DT-CCS	TM-4SS	—	—	4DRSB	—	949506KT
	Ceiling Firestop / Floor Support		46DVA-FS	4DT-FS	TM-4RDS	SV4BF	—	4DFSP	—	94980612
					TM-CS	SV4SD				
	Attic Radiation Shield / Firestop		—	ADT-41S	TM-4AS	—	—	4DAIS12 (12")	—	94930620A
								4DAIS36 (36")		
	Wall Strap		46DVA-WS	4DTWS	TM-WS	—	—	4DWS	—	949164
	Vinyl Siding Standoff		46DVA-VSS	4DT-VS	TM-VSS	SV4VS	—	4DHVS	—	94800615S
Elbow Strap / Offset Support		46DVA-ES	4DT-OS	TM-OS	—	—	—	—	949264	
Terminal Guard		46DVA-WG	—	TM-HTS	—	—	—	845TG	940164SHRD	
				TM-RHTS				658TG		

- Notes:**
- All listed above co-axial pipes and fittings require Valor 817VAK Adapter Kit to fit Valor's smooth collars (Valor adapter 4DSC-V by American Metal Products may also be used).
 - Follow instructions supplied with each manufacturer's components.
 - Unless otherwise specified, all the parts and assemblies from the above table are to be used with 4" x 6-5/8" pipes.
 - Do not mix components from different vent manufacturers.
 - Termination caps manufactured by RLH Industries or American Metal Products are from Homestyle Chimney Collection and can be ordered in one of the following finishes: a) aluminium; b) black powder coated; c) solid copper.
 - The 720SWK Sidewall Co-Linear Kit can only be installed on the 530 models (CANNOT be used with coal effect models).
 - The DVA5BV DV to BV adapter CANNOT be installed on the MF28 models.

Commonwealth of Massachusetts

State of Massachusetts Carbon Monoxide Detector/Vent Terminal Signage Requirements

For all side wall horizontally vented gas fueled equipment installed in every dwelling, building or structure used in whole or in part for residential purposes, including those owned or operated by the Commonwealth and where the side wall exhaust vent termination is less than seven (7) feet above finished grade in the area of the venting, including but not limited to decks and porches, the following requirements shall be satisfied:

1. INSTALLATION OF CARBON MONOXIDE DETECTORS.

At the time of installation of the side wall horizontal vented gas fueled equipment, the installing plumber or gas fitter shall observe that a hard wired carbon monoxide detector with an alarm and battery back-up is installed on the floor level where the gas equipment is to be installed. In addition, the installing plumber or gas fitter shall observe that a battery operated or hard wired carbon monoxide detector with an alarm is installed on each additional level of the dwelling, building or structure served by the side wall horizontal vented gas fueled equipment. It shall be the responsibility of the property owner to secure the services of qualified licensed professionals for the installation of hard wired carbon monoxide detectors.

a. In the event that the side wall horizontally vented gas fueled equipment is installed in a crawl space or an attic, the hard wired carbon monoxide detector with alarm and battery back-up may be installed on the next adjacent floor level.

b. In the event that the requirements of this subdivision can not be met at the time of completion of installation, the owner shall have a period of thirty (30) days to comply with the above requirements; provided, however, that during said thirty (30) day period, a battery operated carbon monoxide detector with an alarm shall be installed.

2. APPROVED CARBON MONOXIDE DETECTORS. Each carbon monoxide detector as required in accordance

with the above provisions shall comply with NFPA 720 and be ANSI/UL 2034 listed and IAS certified.

3. SIGNAGE. A metal or plastic identification plate shall be permanently mounted to the exterior of the building at a minimum height of eight (8) feet above grade directly in line with the exhaust vent terminal for the horizontally vented gas fueled heating appliance or equipment. The sign shall read, in print size no less than one-half (1/2) inch in size, "GAS VENT DIRECTLY BELOW. KEEP CLEAR OF ALL OBSTRUCTIONS".

4. INSPECTION. The state or local gas inspector of the side wall horizontally vented gas fueled equipment shall not approve the installation unless, upon inspection, the inspector observes carbon monoxide detectors and signage installed in accordance with the provisions of 248 CMR 5.08(2)(a)1 through 4.

(b) EXEMPTIONS: The following equipment is exempt from 248 CMR 5.08(2)(a)1 through 4:

1. The equipment listed in Chapter 10 entitled "Equipment Not Required To Be Vented" in the most current edition of NFPA 54 as adopted by the Board; and

2. Product Approved side wall horizontally vented gas fueled equipment installed in a room or structure separate from the dwelling, building or structure used in whole or in part for residential purposes.

(c) MANUFACTURER REQUIREMENTS - GAS EQUIPMENT VENTING SYSTEM PROVIDED. When the manufacturer of Product Approved side wall horizontally vented gas equipment provides a venting system design or venting system components with the equipment, the instructions provided by the manufacturer for installation of the equipment and the venting system shall include:

1. Detailed instructions for the installation of the venting system design or the venting system components; and

Commonwealth of Massachusetts

2. A complete parts list for the venting system design or venting system.

(d) MANUFACTURER REQUIREMENTS - GAS EQUIPMENT VENTING SYSTEM NOT PROVIDED. When the manufacturer of a Product Approved side wall horizontally vented gas fueled equipment does not provide the parts for venting the flue gases, but identifies "special venting systems", the following requirements shall be satisfied by the manufacturer:

1. The referenced "special venting system" instructions shall be included with the appliance or equipment installation instructions; and

2. The "special venting systems" shall be Product Approved by the Board, and the instructions for that system shall include a parts list and detailed installation instructions.

(e) A copy of all installation instructions for all Product Approved side wall horizontally vented gas fueled equipment, all venting instructions, all parts lists for venting instructions, and/or all venting design instructions shall remain with the appliance or equipment at the completion of the installation.

Appendix A – Lighting Instructions Plate

FOR YOUR SAFETY, READ BEFORE LIGHTING

WARNING: If you do not follow these instructions exactly, a fire or explosion may result causing property damage, personal injury or loss of life.

- A. This appliance has a pilot which must be lighted by hand or by remote control. Follow these instructions exactly. To save gas, turn the pilot off when not using the appliance for a prolonged period of time.
- B. **BEFORE LIGHTING**, smell all around the appliance area for gas. Be sure to smell next to the floor because some gas are heavier than air and will settle on the floor.
- WHAT TO DO IF YOU SMELL GAS
- Do not try to light any appliance.
 - Do not touch any electric switch; do not use any phone in your building.
 - Immediately call your gas supplier from a neighbor's phone. Follow the gas supplier's instructions.
 - If you cannot reach your gas supplier, call the fire department.
- C. Use only your hand to push in or turn the control knobs. Never use tools. If the knobs will not push in or turn by hand, **don't try to repair them; call a qualified service technician. Force or attempted repair may result in a fire or explosion.**
- D. Do not use this appliance if any part has been under water. **Immediately call a qualified service technician** to inspect the appliance and to replace any part of the control system and any gas control, which has been under water.

LIGHTING INSTRUCTIONS

1. STOP! Read the safety information above. Dependent on model, switch #1 may be mounted directly to valve see Fig 2A.

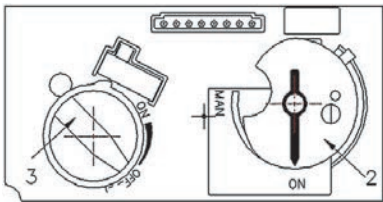

Fig 1

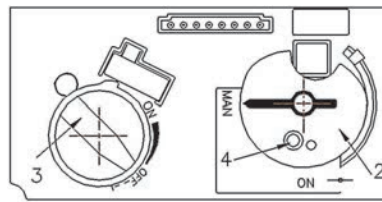

Fig 2

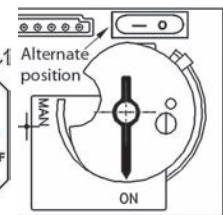



Fig 2A

2. SET ON/OFF SWITCH (1) TO "OFF" POSITION.

- Wait five (5) minutes to clear out any gas, then smell for gas, including near the floor. If you smell gas, STOP! Follow "B" in the safety information above on this label. If you don't smell gas, go to the next step.
3. AUTOMATIC IGNITION (fig. 1): Locate the pilot (fig 3.) inside of firebox at Left Hand side.
- ON/OFF switch (1) in ON position, MAN-knob (2) in ON position; set Flame Adjustment knob (3) to lowest setting (⌚);
 - On the remote control handset, press and hold the 'off' button and  (large flame) simultaneously; a short acoustic signal confirms the start has begun;
 - Further short acoustic signals indicate the ignition process is in progress;
 - When the pilot is lit, the Flame Adjustment knob (3) will automatically rotate to the highest setting.
 - Press the  (small flame) on the remote control handset to reduce the flame height.

4. MANUAL IGNITION (fig. 2): With the window off, locate the pilot (fig. 3) inside of firebox at Left Hand side;

- ON/OFF switch (1) in ON position, MAN-knob (2) in MAN position;
 - Set Flame Adjustment knob (3) to the lowest setting (⌚);
 - Push down the metallic core (4) with a pen or similar instrument; this will establish the pilot gas flow;
- Light gas at the pilot (5) with a match;
- Continue holding down metal core (4) for about 10 seconds; after release, pilot should remain lit;
- If the pilot will not stay lit after several tries, turn the gas control knob (3) to "OFF" (⌚) and call your local service technician or gas supplier.

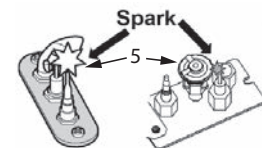



Fig 3

Reinstall the window and set the MAN-knob (2) to "ON"; turn Flame Adjustment knob (3) up (⌚) or down manually or use the up/down 'flame' buttons on the remote control handset to adjust the flame height.

TO TURN OFF GAS TO APPLIANCE

1. AUTOMATIC SHUT-OFF (using the remote control handset):
- Press and hold the  (small flame) on the remote control handset to shut-off the main burner gas flow;
 - Press "OFF" button on remote handset to shut-off the appliance, including pilot flame.
2. MANUAL SHUT-OFF (using only the ON/OFF switch (1))
- Press "O" the ON/OFF switch (1) to shut-off the appliance.

Appendix B – Remote Control Operation

Radio Frequency

315 MHz for USA and Canada.

This device complies with Part 15 of the FCC Rules and with Industry Canada license-exempt RSS standard(s). Operation is subject to the following two conditions:

- (1) this device may not cause harmful interference, and
- (2) this device must accept any interference received, including interference that may cause undesired operation.

NOTE: Before using the remote control system for the first time, the receiver and the handset must be synchronized. See *Remote Control Pairing* in this manual.

IMPORTANT: BEFORE YOU BEGIN, please note that on this system, the settings of time, temperature and automatic ON/OFF **can only be programmed when the function display is flashing.** Be patient when programming as it can take a few seconds to set.

Note: In the TEMP or TIMER modes, the remote handset senses the room temperature and adjusts the flame accordingly.

To communicate, the handset should be within 15 feet (4.5 meters) of the fireplace.

Do not leave the handset on the mantel or hearth.

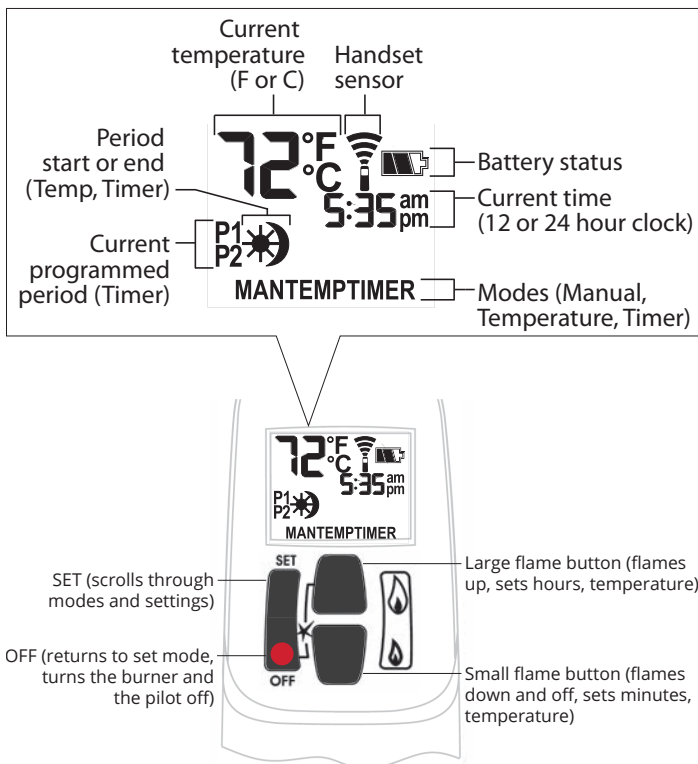

Turn Fireplace ON

Press ● + 🔥 buttons until you hear a short beep; release buttons.

Beeping continues until pilot is lit.

Burner lights to maximum flame height and handset goes automatically to manual (MAN) mode.

NOTES:

On the valve, MAN button must be at ON, in full counter-clockwise position .

ON/OFF switch (if equipped) must be in I (ON) position.

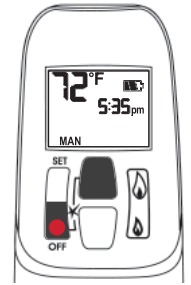

Turn Fireplace OFF

Press ● button.

When pilot is just turned off, wait 2 minutes to light it again.

Standby Mode (Pilot Flame)

Press and hold 🔥 to set fireplace to pilot.

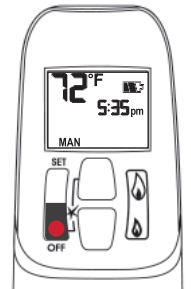

Adjust Flames Height

With pilot lit, press and hold buttons:

🔥 = increase flame height

🔥 = decrease flame height or set to pilot

For fine adjustment, tap buttons.

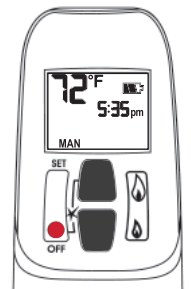

Express Low and High Fire

Double-click buttons:

🔥 = increase flame to maximum height "HI"

🔥 = decrease flame minimum height "LO"

NOTE: Flame goes to high fire first before going to designated low fire.

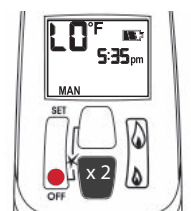
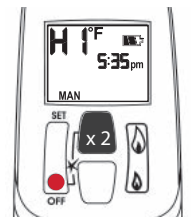

Appendix B – Remote Control Operation

Setting °C/24-hr or °F/12-hr clock

In MAN mode, press and hold ● + 🔥 buttons until temperature / clock display changes from

°F / 12-hour ↔ °C / 24-hour

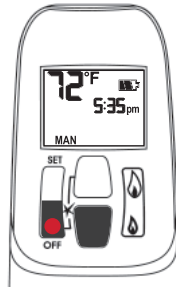

Setting Time

The time display will flash after either:

- installing the battery, or
- pressing 🔥 + 🔥

To set the time, press buttons:

🔥 = hour

🔥 = minutes

Press ● or wait to go back to MAN.

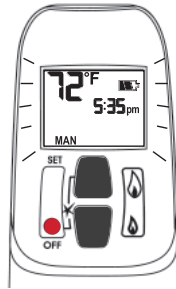

Modes of Operation

Briefly pressing SET cycles through modes of operation.

MAN > ⚡TEMP > 🌙TEMP > TIMER > MAN

NOTE: Press 🔥 or 🔥 to reach MAN mode.

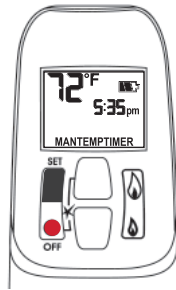

MAN Manual Mode

Manual flame height adjustment.



⚡TEMP Daytime Temperature Mode

When pilot is lit, room temperature is measured and compared to set temperature. Flame height automatically adjusts to reach Daytime Set Temperature.



🌙TEMP Night time Setback Temperature Mode

When pilot is lit, room temperature is measured and compared to set temperature. Flame height automatically adjusts to reach Night Time Setback Temperature.

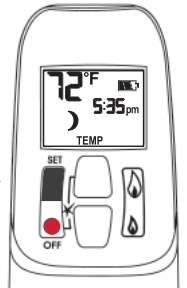

TIMER Timer Mode

When pilot is lit, two periods of time (P1 and P2) can be programmed to use Daytime and Night time temperatures at specific times.

Note: Display shows set temperature every 30 seconds.



Set the different parameters when they are flashing.

Appendix B – Remote Control Operation

Setting high / low Temperatures

Setting “DAYTIME” high temperature.

Default Settings: TEMP 23 °C/74 °F

Press SET to scroll to TEMP

Hold SET button until TEMP flashes.

To set Daytime Temperature:

= increases temperature.

= decreases temperature.

Press or wait to complete setting.

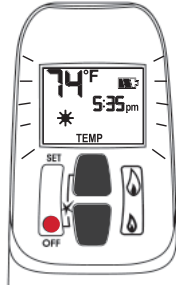

Setting “NIGHT TIME SETBACK” low temperature.

Default Settings: TEMP “--” (OFF)

Press SET to scroll to TEMP

Hold SET button until TEMP flashes.

To set Night Time Temperature:

= increases temperature.

= decreases temperature.

Press or wait to complete setting.

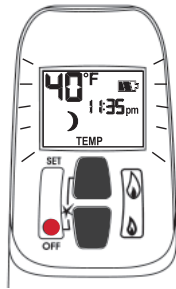

Setting Program Timers

You can program two periods of time between 12 am and 11:50 pm in each 24-hour cycle.

Programs P1 and P2 must be set in the following order during a 24-hour cycle: **P1** , **P1** , **P2** and **P2** .

= Day Time temperature (high) program period

= Night Time temperature (low) program period

Default Settings:

Program 1: **P1** 06:00 am **P1** 08:00 am

Program 2: **P2** 11:50 pm **P2** 11:50 pm

Press SET to scroll to **TIMER**.



If **P1** = **P1** or **P2** = **P2** , programming is cancelled.

To keep fireplace ON all night, set **P2** at 11:50 am and **P1** at 12:00 am.

If you want to program only one period, program **P1** and **P1** with desired times then **P2** and **P2** with the same time as **P1** .

Setting P1 time—high temperature.

Hold SET button until **P1** is displayed and time flashes.

To set time:

= hour

= minutes

Press or wait to complete setting.

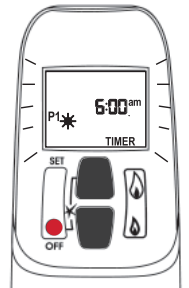

Setting P1 time—low temperature.

Hold SET button until **P1** is displayed and time flashes.

To set time:

= hour

= minutes

Press or wait to complete setting.

Appendix B – Remote Control Operation

Setting P2 high and low temperature times.

Repeat same steps as Setting P1.

When all settings are complete, press ● to save them.

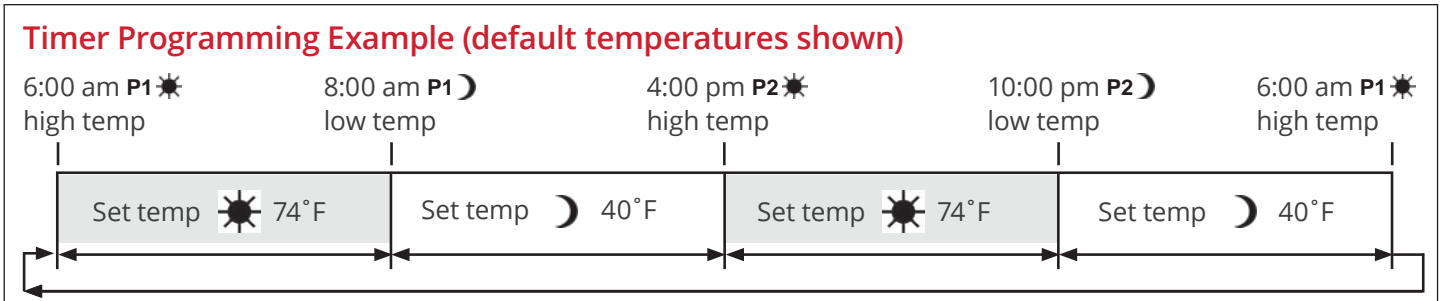

Automatic Turn Down

8-Hour no Motor Movement

The valve will turn to pilot flame if there is no motor movement for an 8-hour period.

Automatic Shut-Off

Low Batteries Receiver. With low battery power in the battery holder the system shuts off the fire completely. This does not apply when the power supply is interrupted.

On-Demand Pilot (7 Day Shut-Off). This green feature eliminates gas energy consumption during extended appliance inactivity. When the appliance is inactive for an extended period of time the system automatically extinguishes the pilot. This feature helps the consumer realize cost benefits by automatically eliminating energy consumption during non-heating months and limited use.

The programmed length of inactivity to activate the system is specified by the appliance manufacturer and cannot be altered in the field.

Low Battery Indication

! Caution

DO NOT USE a screwdriver or other metallic object to remove batteries from holder. This could cause a short-circuit.

Handset: The battery icon  will show when the battery needs to be replaced. Replace with one 9 V **alkaline** battery.

Battery holder: Frequent 'beeps' for 3 seconds when the valve motor turns indicate the batteries need to be replaced in battery holder. Replace with four 1.5 V **alkaline** batteries.

Handset / Receiver Match

The remote control handset and receiver are programmed to function together. In case of a replacement of the handset or the receiver, you will need to reset the receiver to allow them to function together. Contact your dealer for details.

Appendix C – Spare Parts

	Description	Part no.
1	Side wall support (2)	330A898
2	Rear wall support	320B320
3	Velcro strip	4000022
4	Port cover	4000828AH
5	Inner vent collar	340B174
6	Inner vent collar seal	620B973
7	Top vent collar seal	568399
8	Top vent cover plate	330A902
9	Wall bracket spacer (2)	320B360AZ
10	Outer vent collar seal	568399
11	Outer vent collar	330A888
12	Restrictor plates (2)	4002895
13	Adjustable plates (2)	4002896
15	Window unit	050A216
16	Window screw assy (2)	000B214S
17	Hot glass warning plate	4003093
18	Burner module (natural gas)	4001722
	Burner module (propane gas)	4001723
19	Burner unit incl. #22 (natural gas)	3000025
	Burner unit incl. #22 (propane gas)	740K185
20	Aeration shutter slider (natural gas)	4002345
21	Aeration shutter cover (natural gas)	4002346
22	Aeration shutter slider (propane gas)	320B293
23	Flashback shield (propane gas)	3000371
24	Pilot unit complete (natural gas)	4000062
	Pilot unit complete (propane gas)	4000063
25	Pilot injector (natural gas)	4002511
	Pilot injector (propane gas)	720A195
26	Thermocouple	4000061
27	Hooked olive for pilot	720A196
28	Electrode	720A543
29	Electrode nut	720A200
30	Olive nut for pilot	420K385
31	Pilot shield	4000144
32	Pilot support bracket	330A904
33	Main burner pipe	030A225
34	Olive nut	220K567
35	Olive	420K342
36	Base support bracket (2)	330A894
37	Spacer angle (2)	4000355
38	Elbow injector (natural gas)	720A580
	Elbow injector (propane gas)	9730013
39	Pilot pipe	030A226
40	Snap off olive nut	220K913
41	Window support	320B399
42	Switch bracket	4001070
43	Switch with cable	4001036
44	Cable interrupter/receiver	4001035
45	Interrupter block	4001037

	Description	Part no.
46	GV60 Valve (natural gas)	4003094
	GV60 Valve (propane gas)	4003107
47	Ignition cable	4001039
48	Ignition cable sleeve	4002244
49	Receiver G6R-R3AM-ZV (CP)	4001911
50	Wiring harness	4001187
51	Handset G6R H3T5-ZV (BJ)	4001910
52	Wall mount holder	9000008
53	Auxiliary battery holder	4006553
54	Battery holder cable 1500 mm	4006552
55	GV60 Valve repair kit (not included)	4004544
56	Ceramic coals & liners set	530CSK
57	Ceramic coal set	000B245
58	Centre left coal	640K615
59	Base coal	650K237
60	Centre right coal	640K616
61	Front right coal	640K618
62	Front left coal	640K617
63	Ceramic reversible walls set	4001160
64	Rear reversible panel	4001161
65	LH reversible panel	4001162
66	RH reversible panel	4001163
67	Traditional logs & liners set	530LSK
68	Traditional log set	4000162
69	Right middle log	4000372
70	Right side front log	4000470
71	Front log	4000370
72	Base log	4000368
73	Left middle side log	4000371
74	Rear log	4000369
75	Ceramic reversible walls set	4001160
76	Rear reversible panel	4001161
77	LH reversible panel	4001162
78	RH reversible panel	4001163
79	Ceramic rocks & liners set	530RSK
80	Top far left rock	4001867
81	Top left rock	4001868
82	Top right rock	4001869
83	Top far right rock	4001870
84	Left rock	4001877
85	Right rock	4001878
86	Bottom left rock	4001874
87	Bottom center rock	4001875
88	Bottom right rock	4001876
89	Middle left rock	4001871
90	Middle center rock	4001872
91	Middle right rock	4001873
92	Rock base	4001880

Appendix C – Spare Parts

	Description	Part no.
93	LH reversible wall	4001162
94	Rear fluted wall	4001881
95	RH reversible wall	4001163
96	Rock base support	4001882AH
97	Ceramic platform	4001879
98	Driftwood Kit	530DWK
99	Log Set (including pebbles)	4005603
100	Base log	4005887
101	Rear log	4005888
102	Left log	4005889
103	Right log	4005890
104	Centre log	4005891
105	Brown beach pebble	4003082
106	Small grey beach pebble	4003086
107	Grey beach pebble	4003083
108	Small beige beach pebble	4003087
109	Metal platform	4006017AH
110	Rear liner panel fluted	4001881
111	Reversible LH brick/fluted panel	4001162
112	Reversible RH brick/fluted panel	4001163
113	Rear liner holder support	4001882AH

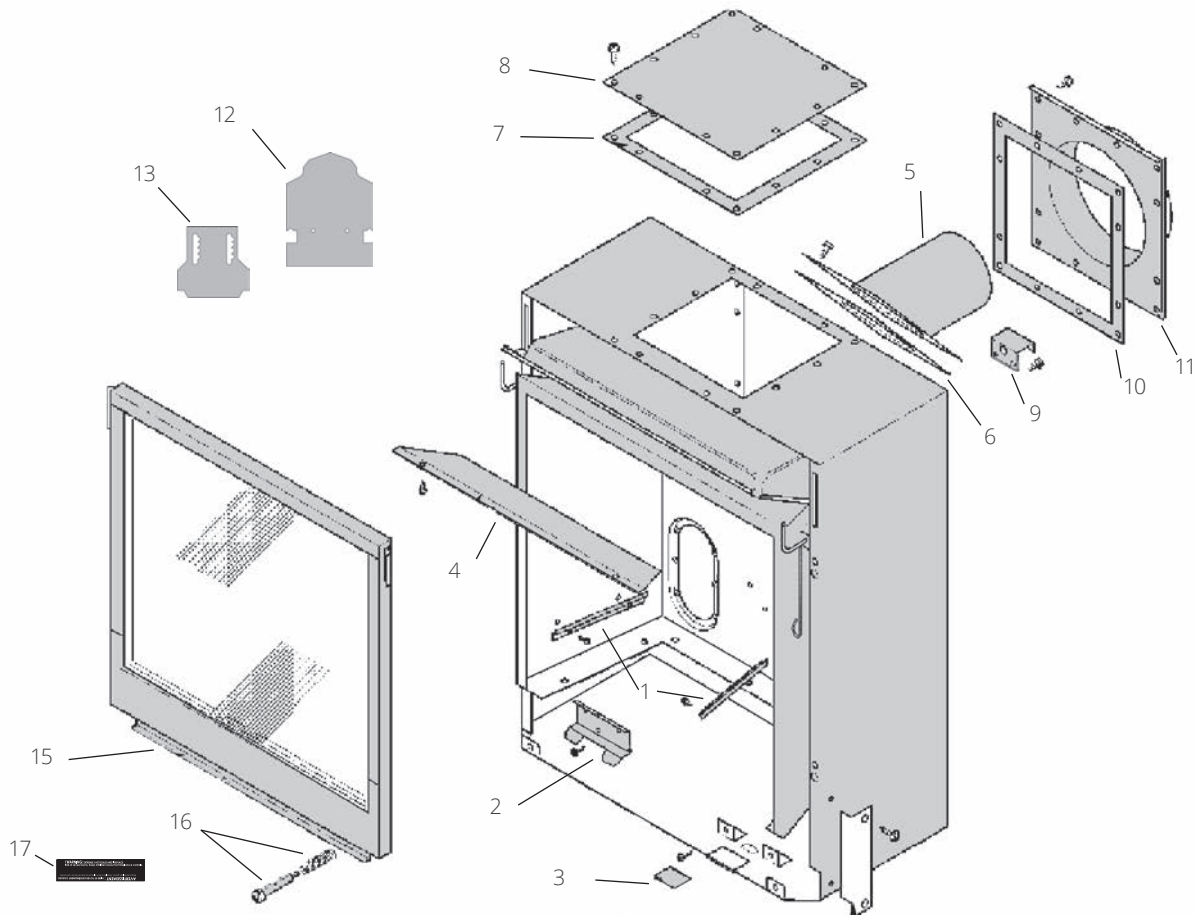

Appendix C – Spare Parts

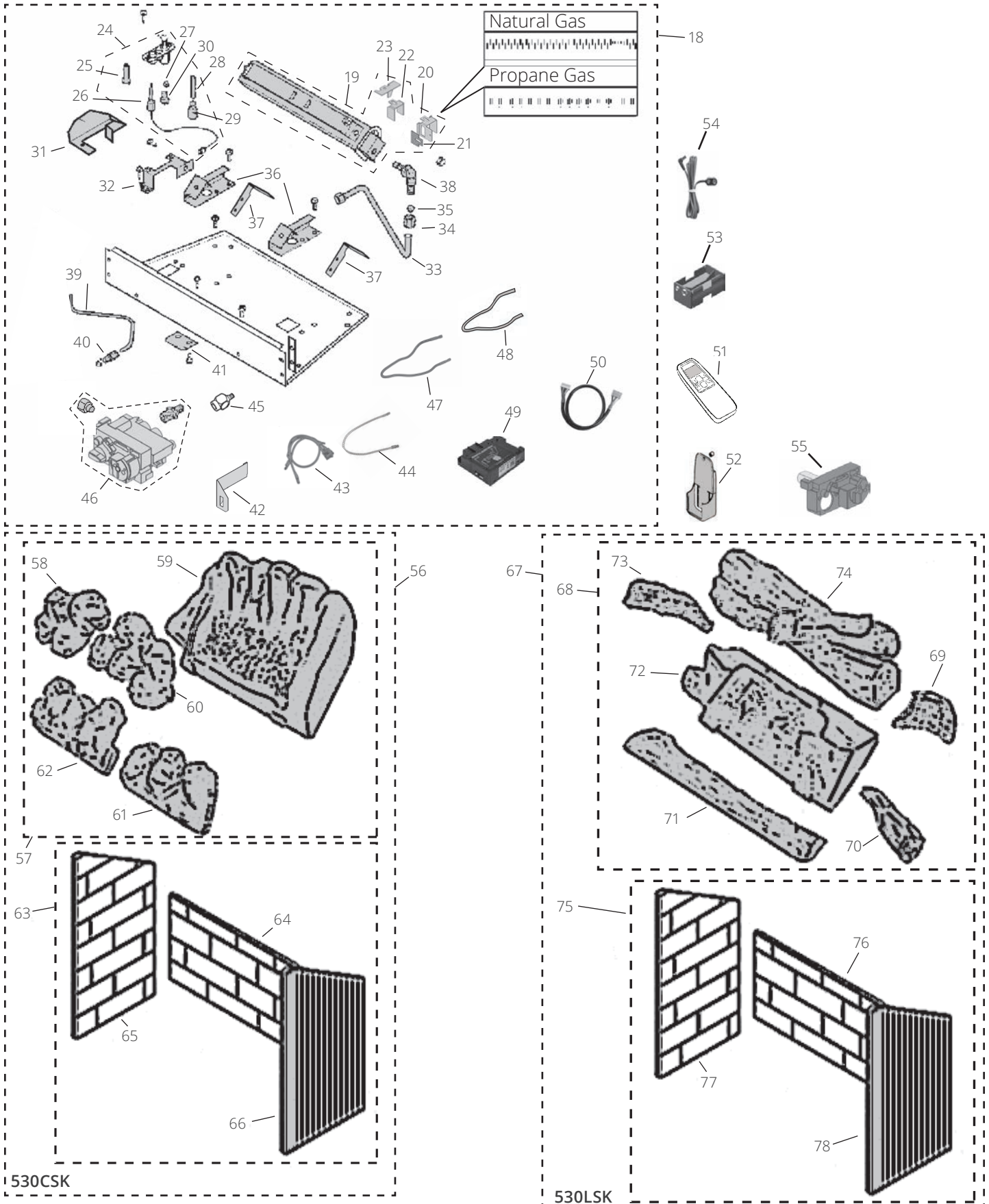

Appendix C – Spare Parts

