

TECHNICAL SPECIFICATIONS

VOLTS		120
AMPS		12.5
WATTS		1500
HEATER	HIGH	1500 watts
	LOW	750 watts
NO HEATER		22 watts
LAMPS	QUANTITY	LED
	WATTS	
	TOTAL WATTS	22 watts
ROTOR MOTOR		1 at 5 watts
HEIGHT, WIDTH, DEPTH		28 x 25 5/8 x 17 1/2"
GLASS VIEWING OPENING		9" x 22"
SURROUND SIZE		
SHIPPING SIZE		32" x 28 3/4" x 23"
SHIPPING WEIGHT		69 lbs
	UNIT	
GLASS FRONT		Included
PLUG LOCATION		Back
CORD LENGTH		70"
APPROX. HEATING AREA		400 sq ft

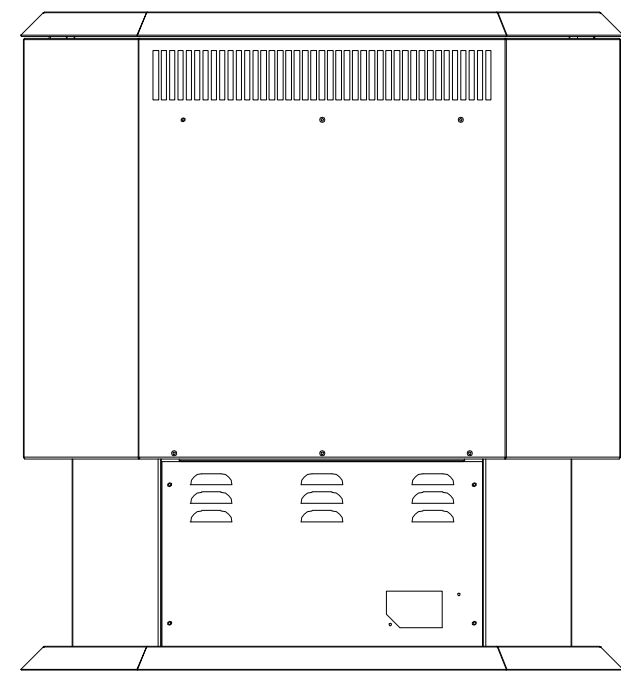
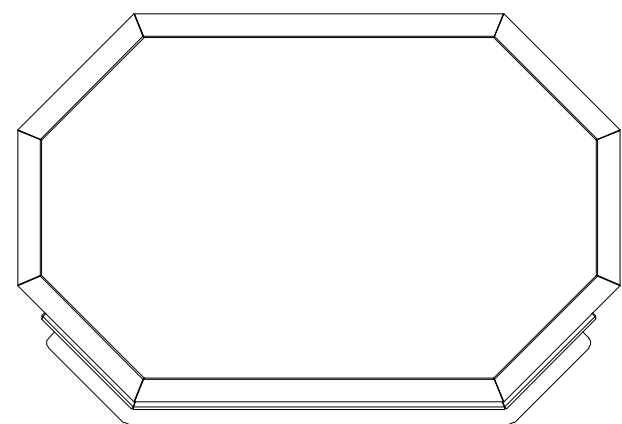
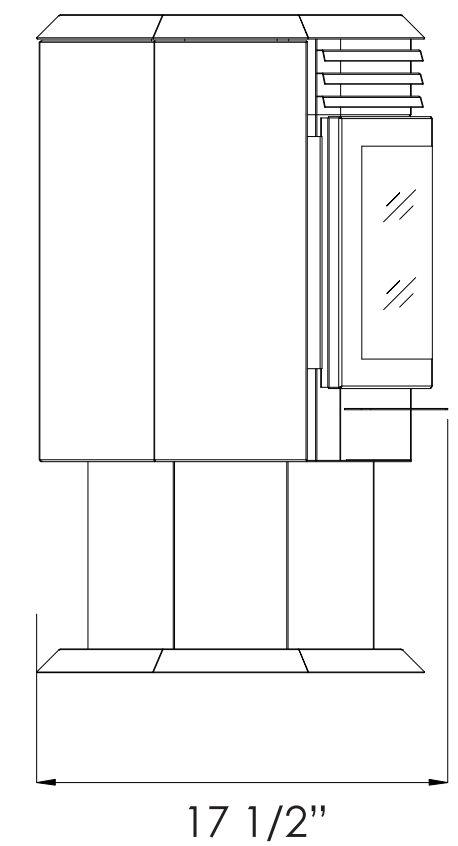
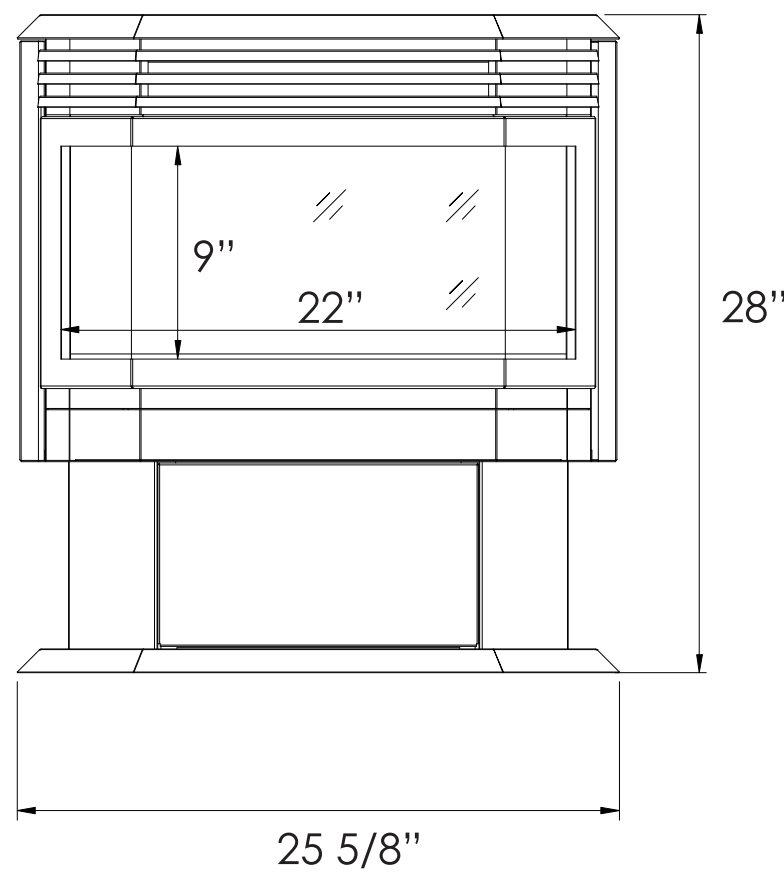

SERIES	MODEL		REV
FREE STAND	FS-26-922		1
SCALE 1" = 1'-0"	DATE: 5/1/2016	SHEET 1 OF 1	

TECHNICAL SPECIFICATIONS

VOLTS		120
AMPS		12.5
WATTS		1500
HEATER	HIGH	1500 watts
	LOW	750 watts
NO HEATER		22 watts
LAMPS	QUANTITY	LED
	WATTS	
	TOTAL WATTS	22 watts
ROTOR MOTOR		1 at 5 watts
HEIGHT, WIDTH, DEPTH		71.2 x 65.2 x 44.5 cm
GLASS VIEWING OPENING		23.00 x 55.8 cm
SURROUND SIZE		
SHIPPING SIZE		81 x 72.5 x 57.5 cm
SHIPPING WEIGHT		31 kg
	UNIT	
GLASS FRONT		Included
PLUG LOCATION		Back
CORD LENGTH		193 cm
APPROX. HEATING AREA		37 sqm

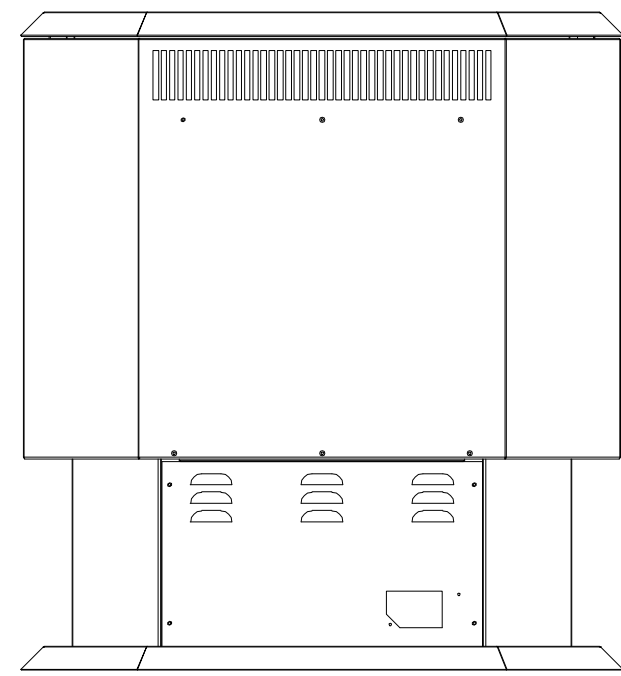
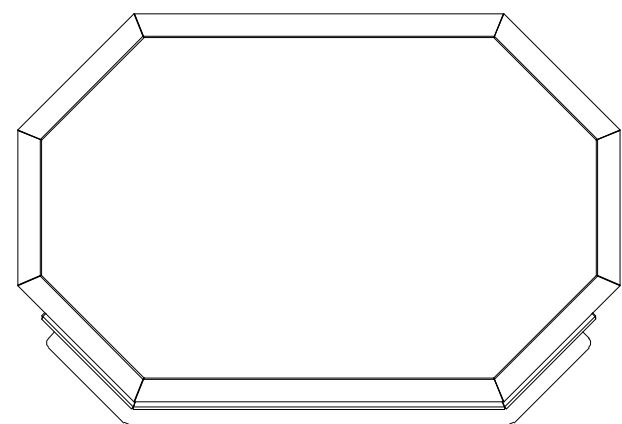
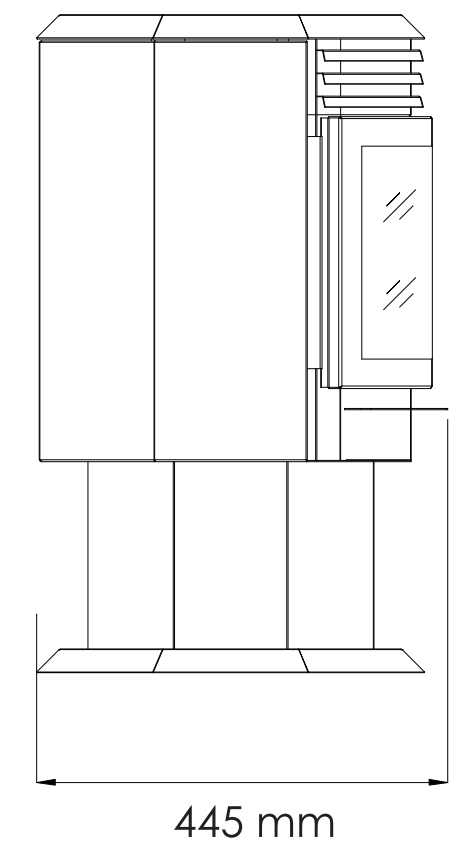
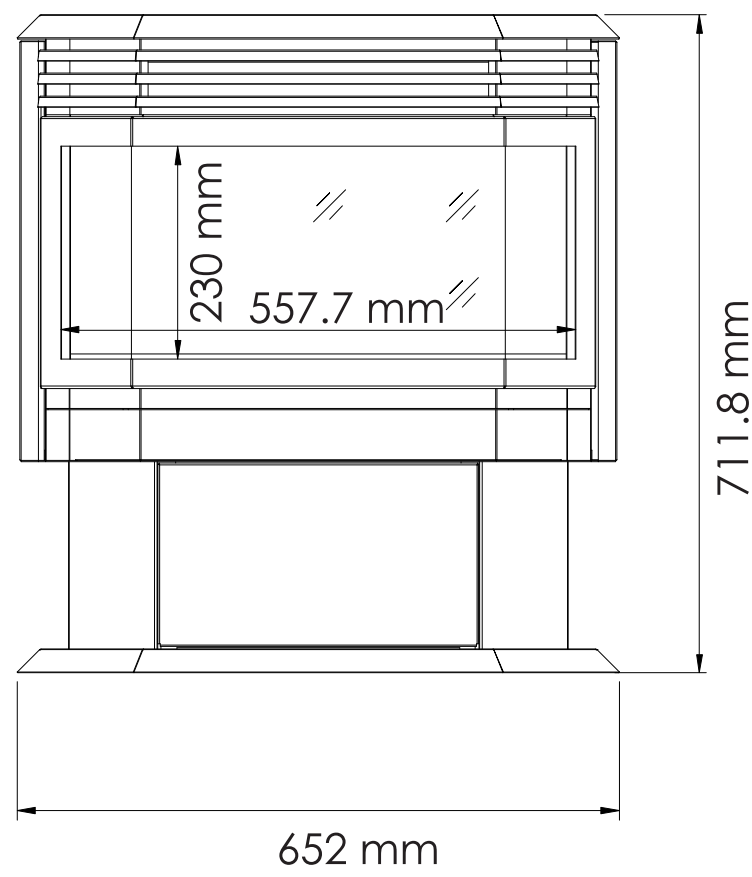

SERIES	MODEL		REV
FREE STAND	FS-26-922		1
SCALE 1:12	DATE: 5/1/2016	SHEET 1 OF 1	